

Kerr Consumables, Products and Solutions

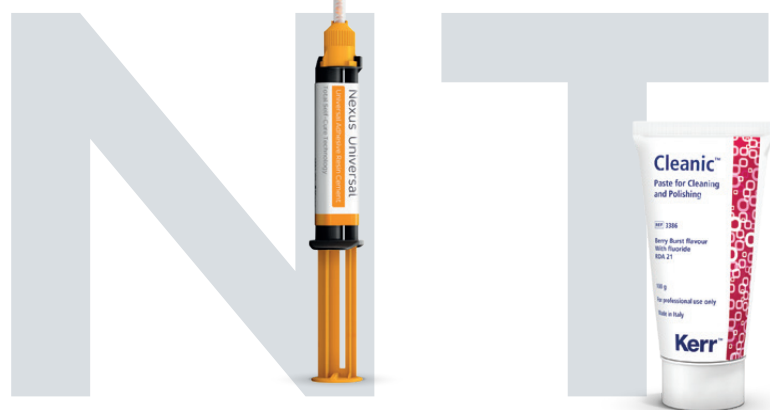

WORLD

Kerr[™]





1 Prevention

1.1	Surface disinfectants	8-9
1.2	Barriers for dental practice	10-12
1.3	Splash protection	13
1.4	Air/water syringe tips	13-14
1.5	Sterile examination instruments	14
1.6	X-ray protection	15
1.7	X-ray holders	15-21
1.8	Perio instruments	22
1.9	Toothpaste	22
1.10	Products with Chlorhexidine	23-24
1.11	Oral prophylaxis workflow	25
1.12	Prophy pastes	26-27
1.13	Cups and brushes	28-30
1.14	Implant prophylaxis	31
1.15	Lip retractor and trays	32-32
1.16	Instrument reprocessing	33
1.17	Office organisation	34-37

2 Endodontics

2.1	Patient preparation	40
2.2	Diagnosis	41
2.3	Shaping	42-53
2.4	Irrigation	54
2.5	Obturation/fill	55-61

3 Restoratives

3.1	Burs	64-87
3.2	Impression materials	88-97
3.3	Temporisation	98-100
3.4	Bonding agents	101-107
3.5	Composites	108-123
3.6	Permanent cements and liners	124-131
3.7	Curing lights	132-133
3.8	Finishing and polishing	134-142
3.9	Alloys	143-144
3.10	Restorative accessories	145-157
3.11	Laboratory products	158-171

Exceeding your expectations: The Kerr Dental portfolio

From the smallest restorative accessory to externally validated prevention solutions and sophisticated endodontic and filling technologies, the Kerr Dental portfolio confers efficiency and compatibility throughout the practice workflow.

Our products are developed in close consultation with clinicians. This strong relationship and combined with a deep understanding of what happens during dental treatments are what enable dentists to optimise their procedures at each step. Under our three flagship brands — Kerr Prevention, Kerr Endodontics and Kerr Restoratives, our aim is to support dentists in:

- Innovating and growing their practice with advanced yet intuitive technologies
- Experiencing a seamless transition between each treatment step through the use of fully compatible solutions
- Finding solutions that can perfectly complement their skills and best of control and peace of mind at once.

Kerr[™] PREVENTION

Helping patients achieve and maintain excellent oral health, and keeping dental practices everywhere safe from cross-infection.

Kerr[™] ENDODONTICS

Enabling the navigation of even the hardest of paths with endodontic products that give confidence and control. For each step. For every dentist.

Kerr[™] RESTORATIVES

Beautiful restorations from start to finish, thanks to unique solutions combining technology and ease of use. For direct, indirect and laboratory needs.



One brand for all prevention needs

The Kerr Prevention range offers hygienists and dental assistants predictable results during prophylaxis as well as room preparation and turnover.

From oral health to office organisation, instrument reprocessing and infection prevention, our practical and proven solutions are designed to optimise each step of the workflow.

The range includes the award winning 3-in-1 disposable towelettes, CaviWipes™, the One-Step paste for cleaning and polishing with patented perlite technology, Cleanic™, and the multi-awarded disposable air/water syringe tips, Seal-Tight™.





Protect what matters



Dental surface disinfectants are essential elements of your infection control procedure.

Because contact surfaces in your dental operatory can act as an easy transmission route for germs, proper cleaning is critical in helping to reduce the threat of cross-contamination.

Kerr range of disinfectants for medical and dental device surfaces is available as easy to use wipes or in spray format.

In addition to the minimal cost and ease of using surface disinfectants, having a quick contact time is also extremely beneficial to staff members when turning over a dental operatory.

1.1 Surface disinfectants

CaviWipes™ & CaviCide™

Liquid and Wipe Surface Disinfectants

CaviWipes™ and CaviCide™ are broad-spectrum medical device surface disinfectant, with clinically relevant efficacy claims: bactericidal, virucidal, fungicidal, tuberculocidal and yeasticidal.

These ready to use multipurpose intermediate level disinfectants are made for use on hard, non-porous surfaces of non-invasive medical devices within dental practices, including patient care areas and laboratories.

CaviWipes and CaviCide kill organisms that pose a threat in today's environment and can help reduce the risk of cross contamination on treated non-invasive medical device surfaces and doing so may help alleviate your important disinfection concerns.

Fast, easy and multi-surface compatible

Kill Most Pathogens in 3 minutes or Less² – Faster change over time and helps lower risks of cross contamination.

Ready-To-Use Products – No dilution or mixing required.

Saves Time & Inventory – A cleaner and disinfectant in one.

Low Alcohol Content – Less than 20%, which offers excellent material compatibility.

Safe – Fragrance and colorants-free. Do not contains phenol, aldehyde, bleach or other toxic chemicals



Spectrum and kill times

Organism	Kill time
Mycobacterium tuberculosis var: bovis (BCG) ⁵	3 minutes
Methicillin Resistant Staphylococcus aureus (MRSA) ⁹	3 minutes
Pseudomonas aeruginosa ⁴	1 minute
Salmonella enterica ⁹	3 minutes
Staphylococcus aureus ⁴	1 minute
Vancomycin Resistant Enterococcus faecalis (VRE) ⁹	2 minutes
Staphylococcus aureus with reduced susceptibility to vancomycin ⁹	2 minutes
Enterococcus hirae ⁴	1 minute
Escherichia coli ⁴	1 minute
Proteus mirabilis ⁴	1 minute

Organism	Kill time
SARS-associated Human Coronavirus (SARS-COV-1) ⁵	3 minutes
SARS-associated Human Coronavirus 2 (SARS-COV-2) (COVID-19 Virus) ¹⁰	2 minutes
Human Coronavirus ⁵	2 minutes
Hepatitis B virus (HBV) ⁵	2 minutes
Hepatitis C virus (HCV) ⁵	2 minutes
Human Immunodeficiency Virus (HIV-1) ⁵	2 minutes
Herpes Simplex Virus Types 1 and 2 ⁵	2 minutes
Influenza A2 Virus ⁵	2 minutes
Modified Vaccinia Virus Ankara (MVA) ⁶	5 minutes
Candida albicans ⁷	1 minute ⁸
Trichophyton mentagrophytes ⁹	3 minutes

The CaviWipes and CaviCide family provides time savings, convenient packaging, ease of use, and intermediate-level disinfection in various sizes and in multiple configurations for your office needs. Available in spray, liquid and wipe formats, these products are ideal for cleaning and disinfecting medical devices surfaces.

CaviCide can be used as a disinfectant spray or as a disinfectant immersion solution for non-invasive medical instruments. It is ready-to-use and doesn't require dilution.

CaviWipes and CaviWipes XL are disposable, ready-to-use disinfectant wipes pre-saturated with CaviCide™ solution for the effective removal of dirt and quick and broad-spectrum disinfection. Each Wipe is a durable, non-woven fully saturated towelette that won't dry out and won't bunch up during use.

CaviWipes offers excellent surface contact: available in various formats and sizes – flatpack (17.5 x 22.5 cm) and canister (15.24 x 17.15 cm), (22.9x 30.5 cm). Flat Packs minimize storage space, unclutter counter space, and are resealable. On Canister, the deep well lid and easy access tab provides quick opening and tight closures between wipes.

- 1) EN14476 tested using MVA (Modified vaccinia virus Ankara) as a surrogate representing enveloped virus
- 2) Please refer to organism list for appropriate application time
- 3) AOAC 965.12
- 4) EN 13727, EN 16615, EN 13697, EN 14561 (Clean condition)
- 5) ASTM E1053-11
- 6) EN 14476, EN 16777 (Clean condition)
- 7) EN 13624, EN 16615, EN 13697, EN 14562 (Clean condition)
- 8) If used as a disinfectant spray (EN 13697), the contact time is 1 minutes. If used as an immersion disinfectant solution (EN14562), the contact time is 3 minutes. (Clean condition)
- 9) AOAC 961.02
- 10) ASTM E1053-20

CaviCide	REF/Part No.
CaviCide - 5 l Tank	4731223
CaviCide - Pump for 5 l Tank	4731229
CaviCide - 200 ml Bottle	4731221/15
CaviCide - 700 ml Bottle	4731222/15

CaviWipes™	REF/Part No.
CaviWipes - 160 Pre-Saturated Towelettes (15.24 x 17.15 cm) Canister - Pack of 12	4731160
CaviWipes - 45 Pre-Saturated Towelettes (17.5 x 22.5 cm) Flat Packs - Pack of 20	4731245
CaviWipes XL - 65 Pre-Saturated Towelettes (22.9 x 30.5 cm) Canister - Pack of 12	4731065

1.2 Barriers for dental practice

Disposable dental barriers and sleeves offer many advantages in infection control by helping the clinician reduce clean-up time, and blood and viral cross-contamination. They also support the reduction of the use of chemicals, which may help to increase the longevity of your equipment and furniture.

Chair Sleeve and No-Slip Chair

The extra-wide No Slip Chair Sleeve is made with a special copolymer plastic, with its gripping bottom surface keeping the sleeve in place.

Chair Sleeve

REF/Part No. 3800

69.9 cm x 61 cm, Pack of 225

No-Slip Chair Sleeve

REF/Part No. 3870-NS

122 cm x 142 cm, Pack of 150

No-Slip Chair Sleeve XL

REF/Part No. 3850 XL

73.7 cm x 203 cm, Pack of 125



Chair Sleeve

Headrest Cover

Disposable plastic cover for headrests.

Headrest Cover

REF/Part No. 3511

27.9 cm x 24.1 cm, Pack of 250

Headrest Cover

REF/Part No. 3514

35.6 cm x 24.1 cm, Pack of 250



Headrest Cover

Syringe Sleeve

Disposable sleeve made to cover the 3-way syringe, HVE and saliva ejector valves.

Syringe Sleeve

REF/Part No. 3760

6.4 cm x 25.4 cm, Pack of 500

Syringe Sleeve WA (with adhesive)

REF/Part No. 3763-WA

6.4 cm x 25.4 cm, Pack of 500

Unique tape strip fastens bag to tubing to prevent sliding.

Syringe Sleeve WO (with opening)

REF/Part No. 3767-WO

6.4 cm x 25.4 cm, Pack of 500

Exclusive pre-cut opening allows the user to simply slide the syringe tip through the end of the bag.



Syringe Sleeve

X-ray Sleeve

The X-ray Sleeve's tapered design protects X-rays from the harmful drying effects of surface disinfectants.

X-ray Sleeve

REF/Part No. 3900

37.5 cm x 65 cm, Pack of 250



X-ray Sleeve

Handpiece Sleeve

The Handpiece Sleeve is a disposable cover for handpieces, ultrasonic scalars and jet polishers. It is made from unique super-soft plastic that allows the user to hold the handpiece easily and maintain tactile feel. The single-piece package makes it simple to insert and apply to the handpiece.

Handpiece Sleeve

REF/Part No. 4000-1

3.13 cm x 25.4 cm, Pack of 500

Fits straight slow-speed handpieces, ultrasonic scalars and jet polishers

Handpiece Sleeve

REF/Part No. 4050

5.1 cm x 25.4 cm, Pack of 500

Fits contra-angle slow-speed handpieces and Midwest Shorty.



Handpiece Sleeve

Cure Sleeve

The Cure Sleeve is a disposable cover for curing light tips. It decreases the possibility of cross-contamination and prevents composite bonding to the end of the tip, which decreases curing depth.

Cure Sleeve

REF/Part No.

Cure Sleeve - fits 7 and 8 mm Tips, Pack of 400

4500

Cure Sleeve - fits 11 mm Tips, Pack of 400

4511-1

Cure Sleeve - fits 13 mm Tips, Pack of 400

4513-1

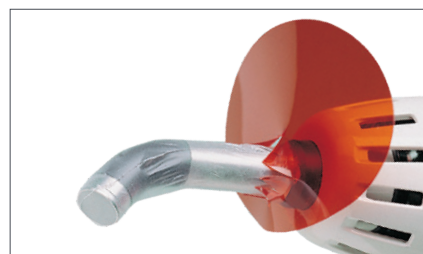

Cure Sleeve

Cure Sleeve Handle Cover

The Cure Sleeve is a disposable cover for curing light handles. The patented design prevents overheating of the curing gun.

Sleeves DEMI

REF/Part No. DEMI-250

Single-use, protective plastic sleeve designed to cover DEMI, Pack of 250

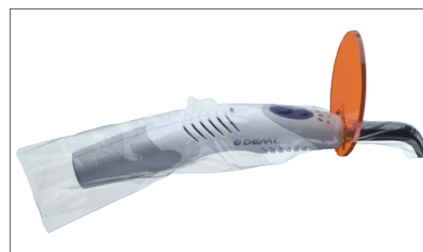

Sleeves DEMI 250

Vision Saver

The Vision Saver is a disposable, orange curing shield that simply slides over the end of the curing tip. Its flexible design allows it to be placed next to the patient's mouth comfortably. This protects dentists and staff from the damaging effects of the intense light. It fits any size tip.

Vision Saver

REF/Part No. 4575

Pack of 400

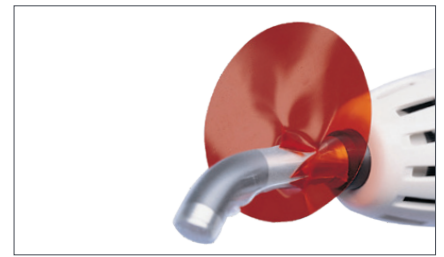

Vision Saver

Light Sleeve

The Light Sleeve, for "T" style light handles, allows the user to slip the plastic sleeve over the handle quickly. Its patented design keeps the sleeve from falling off while in use, yet it is easily removed when finished.

The Light Sleeve is also available for "L" style light handles.

Light Sleeve, "T" Style

REF/Part No. 3600

10.2 cm x 14.6 cm, Pack of 500

Light Sleeve, "L" Style

REF/Part No. 3650

3.8 cm x 20.3 cm, Pack of 500



Light Sleeve, "T" style



Light Sleeve, "L" style

Sensor Covers

Sensor Covers are disposable covers for the sensor on digital X-ray imaging systems.

Sensor Covers

REF/Part No. 3735

3.5 cm x 20.5 cm, Pack of 500

Sensor Covers

REF/Part No. 3736

4 cm x 21 cm, Pack of 500



Sensor Covers

Cover-All

The Cover-All thin, perforated sheet of adhesive plastic effectively covers anything that may be touched during a procedure. It is disposable, easy-to-apply and remove, and will not leave any residue.

Cover-All

REF/Part No.

Cover-All - Clear, 10.2 cm x 15.2 cm sheets, Pack of 1,200

3700-C

Cover-All - Blue, 10.2 cm x 15.2 cm sheets, Pack of 1,200

3710-B

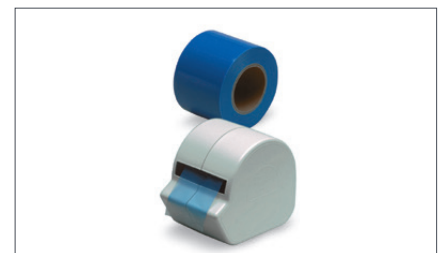

Cover-All

1.3 Splash protection

Bib-Eze™

Disposable bib holders

Bib-Eze™ Disposable Bib Holders are lightweight stretchable paper holders that attach to the dental napkin with their easy-to-peel, self-adhesive ends. The bib holder can easily be removed after the procedure and thrown away alongside the dirty napkin, thus reducing the risk of cross-contamination.



Bib-Eze™

Bib-Eze

REF/Part No. 35053

Bib-Eze single-use Disposable Bib Holders Box of 250

1.4 Air/water syringe tips

Seal-Tight™

Disposable air/water syringe tips

Seal-Tight™ is a disposable syringe tip with a built-in rubber O-ring seal making syringes work like new every time. The tips are fast to change thanks to the easy-to-install push-button converter. The interlock system eliminates wear and tear at the insertion point of the air/water syringe.

Benefits:

The Seal-Tight ensures dry air every time and removes the risk of moisture damage during procedures.

- Single-use, eliminates the risk of cross-contamination
- Saves time wasted on processing metal tips
- Plastic tip can bend to 90° angle
- Easily retracts lips and cheeks without bending

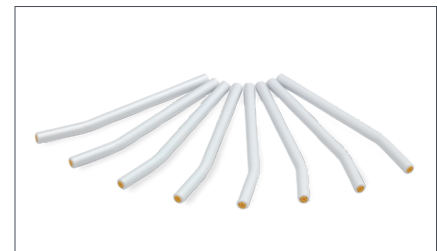

Seal-Tight



Seal-Tight — Assorted Colours

Seal-Tight

REF/Part No. PE77200

Seal-Tight - Dispenser Pouch of 200 Tips

Seal-Tight — Assorted Colours

REF/Part No. 72200

Seal-Tight - Assorted colours - Dispenser Pouch of 200 Tips

Seal-Tight Adapters

Easy-to-mount set of autoclavable adapters

The Seal-Tight offers an easy-to-mount set of 12 autoclavable adapters, custom designed to fit the respective syringe type, ensuring maximum compatibility with the original syringe.

Seal-Tight Adapters	REF/Part No.
Seal-Tight Adapter Snap-on for KaVo air-water syringe 773.000 L	PE77031/K
Seal-Tight Adapter for KaVo air-water syringe E30 (3-Way Hand piece One)	PE77034/K
Seal-Tight Adapter for «Adec» syringes	PE77021/A
Seal-Tight Adapter for «Engle/Marco» syringes	PE77022/M
Seal-Tight Adapter for «Dental-Ez» syringes*	PE77023/D
Seal-Tight Adapter for DCI Standard «Press Ring» syringes**	PE77024/P
Seal-Tight Adapter for Quick Connect «Press Ring» syringes	PE77025/P
Seal-Tight Adapter for Luzzani air-water syringe MINI Light	PE77027/L
Seal-Tight Adapter Snap-on for Cefla/Anthos(bef. 3)/new Castellini/Stern Webber	PE77033/C
Seal-Tight Adapter Snap-on for Sirona air-water syringe Sprayvit L	PE77030/S

* All syringes manufactured after Jan 1997 use 77021/A
 ** Must be used if the syringe was previously modified with another adapter



Seal-Tight Adapter for KaVo 773.000 L Light Syringe



Seal-Tight Adapter for KaVo E30 Syringe

1.5 Sterile examination instruments

Sterile Examination Instruments

Sterile examination instruments provide a practical solution. All materials used in their manufacture are either recyclable or biodegradable. Ready to use and hygienic, they protect against the risk of cross-contamination.

Sterile Examination Instruments	REF/Part No.
Sterile Dental Examination Mirror, Pack of 180	PE9710
Sterile Dental Mirror, Periodontal Probe & Tweezers Kit, Pack of 100	PE9701
Sterile Oral Examination Kit, Pack of 25	PE9401
Sterile Periodontal Examination Kit, Pack of 100	PE9601
Sterile Tweezers, Pack of 200	PE9740



Sterile Oral Examination Kit



Sterile Periodontal Examination Kit



Sterile Dental Examination Mirror

1.6 X-ray protection

Lead-Free X-ray Apron and Panoramic Poncho

Lead-free X-ray garments

Our lead-free aprons provide radiation protection for patients during intra-oral radiography, without the weight of lead. The aprons are made of proprietary alloy sheeting that provides the same protection as lead, but are lighter.

The apron drapes comfortably over the patient and the corduroy backing prevents it from slipping off. The vinyl front and durable stain-resistant binding make it also easy-to-clean.

Aprons are available as panoramic ponchos.



Lead-Free X-Ray Panoramic Poncho

Lead-Free X-ray Apron with Thyroid Collar

REF/Part No. 31439DX

Light Blue - 3,200 g - 58x66 cm

1.7 X-rays holder — Film and phosphor plate holders

X-ray Film and Phosphor Plate Holders Testset

X-ray holders assortment

The X-Ray Film and Phosphor Plate Holders by Kerr provide exact positioning of the film or phosphor plate relative to the tooth - without bending or distorting.

All Kerr film and phosphor plate holders are autoclavable at 134 °C for at least 3 minutes.

X-ray Film and Phosphor Plate Holders Testset

REF/Part No. 1720

6 X-ray holders with Ring (1 Kwik-Bite, 1 Super-Bite Anterior, 1 Super-Bite Posterior, 1 Paro-Bite, 1 Endo-Bite Anterior, 1 Endo-Bite Posterior), 6 Centring Devices.

Kwik-Bite™

X-ray holders for horizontal bite wings

The Kwik-Bite™ is a film and phosphor plate holder for horizontal bite wings (standard bite wings). For assessing approximal caries, overhangs and gaps, crown margins and calculus in the interdental spaces, and also the state of the alveolar ridge.

Compatibility

The Kwik-Bite is compatible with the most commonly used X-ray film formats (1, 2, 3). The Kwik-Bite with Ring is also suitable for indirect digital systems. It is compatible with all major brands of phosphor plate sensors.

Kwik-Bite with Ring

REF/Part No. 1780

5 Kwik-Bite with Ring, 1 Centring Device

Kwik-Bite with Index

REF/Part No. 270

15 Kwik-Bite with index

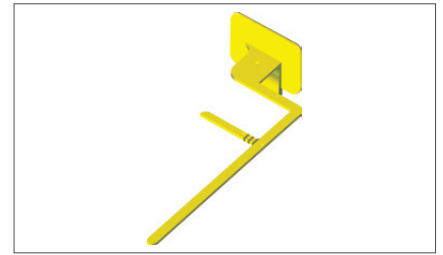

Kwik-Bite with Index

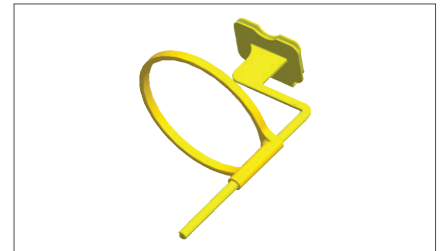

Kwik-Bite with Ring

Super-Bite™

X-ray holders for periapical radiographs

The Super-Bite™ is a film and phosphor plate holder indicated for periapical radiographs of anterior and posterior teeth. The system includes two types of holder – anterior (green) and posterior (red) – for use in all four quadrants.

Compatibility

The Super-Bite with Ring is also suitable for indirect digital systems. It is compatible with all major brands of phosphor plate sensors.

Super-Bite with Ring Assorted Kit

REF/Part No. 1020

2 Super-Bite Anterior, 2 Super-Bite Posterior, 2 Centring Devices

Super-Bite with Ring Refill Packs

REF/Part No.

4 Super-Bite Anterior with Ring, 1 Centring Device 1021

4 Super-Bite Posterior with Ring, 1 Centring Device 1022

Super-Bite with Index Assorted Kit

REF/Part No. 670

4 Super-Bite Anterior, 4 Super-Bite Posterior, 8 Index

Super-Bite with Index Refill Packs

REF/Part No.

8 Super-Bite Anterior, 8 Index 671

8 Super-Bite Posterior, 8 Index 672



Super-Bite Anterior



Super-Bite Posterior

Endo-Bite™

X-ray holders for diagnostic X-rays

The Endo-Bite™ is a special film and phosphor plate holder for diagnostic X-rays of root canal instruments during endodontic treatment, checks on root fillings, as well as inserted pins and screws, and for general use when the bite is blocked (e.g. rubber dam clamps). The system includes two types of holder – anterior (green) and posterior (red) – for use in all four quadrants.

Compatibility

The Endo-Bite is also suitable for indirect digital systems. It is compatible with all major brands of phosphor plate sensors.

Endo-Bite with Ring Assorted Kit

REF/Part No. 1790

2 Endo-Bite Anterior with Ring, 2 Endo-Bite Posterior with Ring, 2 Centring Devices

Endo-Bite with Ring Refill Packs

REF/Part No.

4 Endo-Bite Anterior with Ring, 1 Centring Device

1791

4 Endo-Bite Posterior with Ring, 1 Centring Device

1792

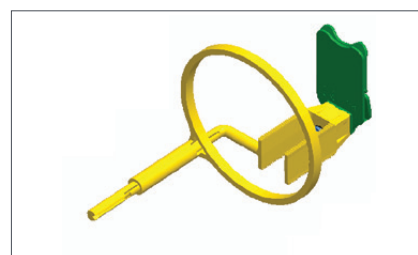

Endo-Bite Anterior

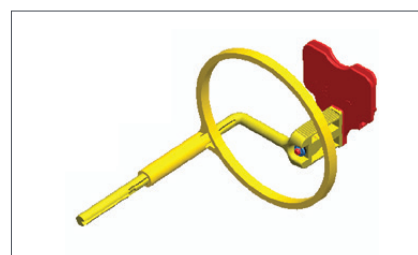

Endo-Bite Posterior

Paro-Bite™

X-ray for perio patients and children

The Paro-Bite™ is a special film holder for assessing the bone level in perio patients and support zones in children (vertical bite wing). It guarantees radiographs without overlaps and therefore eliminates the need for repetition and unnecessary exposure to X-rays. A direct comparison of radiographs over the years can be made for the same patient.

Compatibility

The Paro-Bite™ is compatible with all major brands of phosphor plate sensors.

Paro-Bite with Ring

REF/Part No. 1770

5 Paro-Bite with Ring, 1 Centring Device

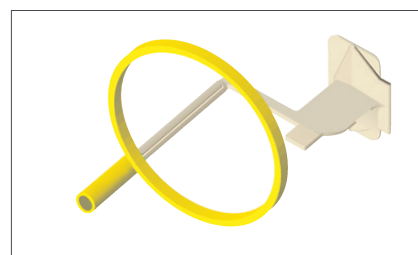

Paro-Bite with Ring

1.7 X-rays holder — Sensor holders for direct digital imaging

Testset Sensor Holder System

X-ray sensor holders

The Kwik-Bite Senso, Super-Bite Senso and the Endo-Bite Senso are designed to ensure superior quality and consistent repeatability in the direct digital imaging of bite wing, periapical and endodontic radiographs.

All Kerr sensor holders accept sensor sizes 0-2 and accommodate all X-ray tubes. Autoclavable at 134 °C, at least 3 min.

Testset Sensor Holder System

REF/Part No. 2720

5 sensor holders with Ring (1 Kwik-Bite Senso, 1 Super-Bite Senso Anterior, 1 Super-Bite Senso Posterior, 1 Endo-Bite Senso Anterior, 1 Endo-Bite Senso Posterior), 5 Centring Devices



Testset Sensor Holder System

Kwik-Bite™ Senso

Universal sensor holder for horizontal bite wings

The Kwik-Bite™ Senso is a universal sensor holder for direct digital imaging of horizontal bite wings. For the patient, the Kwik-Bite Senso offers greater comfort thanks to its optimised bite plate (2.5 mm). The rubber-covered clamps prevent slippage, while a frictionless cogwheel segment enables individual adaptation. The ergonomic release button allows safe removal and quick reuse.

Compatibility

Thanks to its self-centring clamping device, the Kwik-Bite Senso is compatible with all commonly used brands, types and sizes of sensors.

Kwik-Bite Senso Standard Kit

REF/Part No. 2700

4 Kwik-Bite Senso with Ring, 1 Centring Device

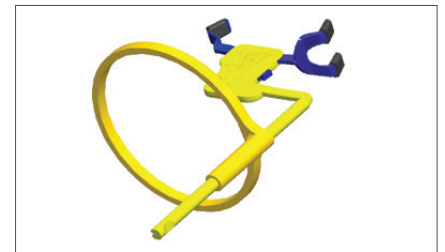

Kwik-Bite Senso

Super-Bite™ Senso

Universal sensor holder for periapical radiographs

The Super-Bite™ Senso is a universal sensor holder system for direct digital imaging of periapical radiographs. The system includes two types of holder – anterior (green) and posterior (red) – for use in all four quadrants. Its fixed apical stop guarantees complete visibility of the apical region. The unlocking knob secures sensor firmly in place. Its design eliminates tearing of infection control bag or barrier cover.

Compatibility

Thanks to its adjustable clamping device, the Super-Bite Senso can accommodate any brand, type or size of sensor with or without cabling.

Super-Bite Senso Assorted Kit

REF/Part No. 2800

2 Super-Bite Senso Anterior with Ring, 2 Super-Bite Senso Posterior with Ring, 2 Centring Devices

Super-Bite Senso Anterior Refill

REF/Part No. 2801

4 Super-Bite Senso Anterior with Ring, 1 Centring Device

Super-Bite Senso Posterior Refill

REF/Part No. 2802

4 Super-Bite Senso Posterior with Ring, 1 Centring Device

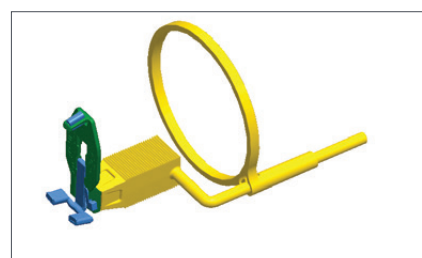

Super-Bite Senso Anterior

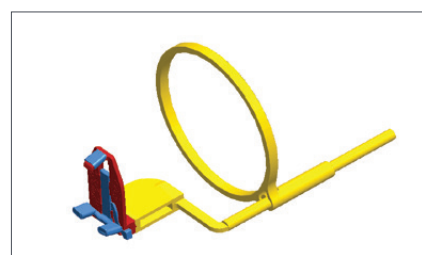

Super-Bite Senso Posterior

Endo-Bite™ Senso

Universal sensor holder for endodontic radiographs

The Endo-Bite™ Senso is a universal sensor holder for direct digital imaging of endodontic radiographs. The system includes two types of holder – anterior (green) and posterior (red) – for use in all four quadrants.

The fixed apical stop guarantees complete visibility of the apical region.

Compatibility

Thanks to its clamping, the device Endo-Bite Senso is compatible with all commonly used brands, types and sizes of sensors.

Endo-Bite Senso Assorted Kit

REF/Part No. 2900

2 Endo-Bite Senso Anterior with Ring, 2 Endo-Bite Senso Posterior with Ring, 2 Centring Devices

Endo-Bite Senso Anterior Refill

REF/Part No. 2901

4 Endo-Bite Senso Anterior with Ring, 1 Centring Device

Endo-Bite Senso Posterior Refill

REF/Part No. 2902

4 Endo-Bite Senso Posterior with Ring, 1 Centring Device

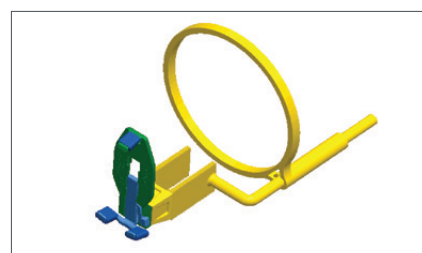

Endo-Bite Senso Anterior

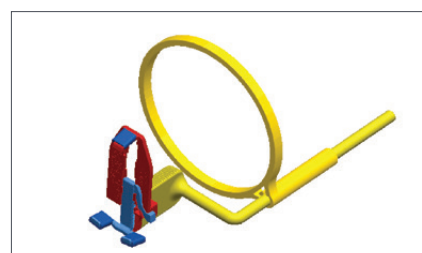

Endo-Bite Senso Posterior

1.7 X-rays holder — Accessories

Centring Devices for X-rays

For film holders, phosphor plate holders and sensor holders

The X-ray dental centring devices for film holders, phosphor plate holders and sensor holders are made of plastic thermoforming material. They are multiple-use, highly radio-transparent devices for accurate placement of X-ray tubes and precise imaging.

X-ray Centring Devices Refill	REF/Part No.
Super-Bite Anterior Centring Devices, Pack of 20	1023
Super-Bite Posterior Centring Devices, Pack of 20	1024
Kwik-Bite/Paro-Bite Centring Devices, Pack of 20	1781
Endo-Bite Anterior Centring Devices, Pack of 20	1793
Endo-Bite Posterior Centring Devices, Pack of 20	1794
Mixed Set of Centring Devices, Pack of 20	1795



Super-Bite Centring Devices



Kwik-Bite Centring Devices



Endo-Bite Centring Devices

Kerr X-ray Centring Rings

Centring rings to be used for all film holders, phosphor plate holders and sensor holders.

Kerr X-ray Centring Rings	REF/Part No. 1721
Pack of 3	



Kerr X-ray Centring Rings

X-rays holder guide

Film and phosphor plate holders

Sensor holders

	Kwik-Bite Horizontal Bite wings	Super-Bite Periapical	Endo-Bite Endodontics	Paro-Bite Vertical Bite wings	Kwik-Bite Senso Horizontal Bite wings	Super-Bite Senso Periapical	Endo-Bite Senso Endodontics
X-Ray film	✓	✓	✓	✓			
Phosphor plate Borderless	✓	✓	✓	✓			
Phosphor plate Bordered	✓	✓	✓	✓			
Sensor Wired and wireless					✓	✓	✓
Centring device*	✓	✓	✓	✓	✓	✓	✓
Testset			✓			✓	

* Centring devices are used in combination with holders with Ring only for rectangular tubes and small round tubes ($\varnothing \leq 5$ cm).
The centring devices facilitate a perfect adjustment of these tubes. With standard round tubes ($\varnothing \approx 6$ cm) there is no need for centring devices.

1.8 Perio instruments

Perio-Probe™

Periodontal probe

The Perio-Probe™ is a colour-coded plastic periodontal probe, available in scale 3/5/7/10. This colour-code permits fast and qualitative evaluation of the presence and depth of periodontal as well as perio-implant pockets. Autoclavable at 134 °C, at least 3 min.

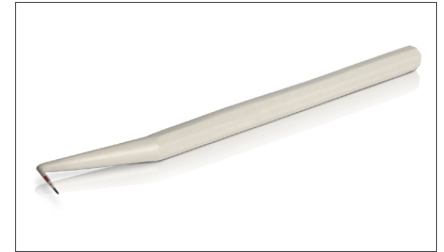

Perio-Probe

Perio-Probe	REF/Part No.
Perio-Probe, Pack of 5	1370
Perio-Probe, Pack of 2	1371



1.9 Toothpaste

Cleanicident™

Toothpaste with whitening effect

Cleanicident™ is a toothpaste that boasts its whitening effect thanks to Perlite, the same technology employed by the market leading prophylaxis paste Cleanic™.

Thanks to the Perlite, a cleansing substance which effectively eliminates stains, deposits and dental film, this special paste has built-in variable abrasion and ensures cleaning power against stains and non-mineralised deposits, which are mainly caused by the consumption of tobacco, tea, coffee and red wine.

Cleanicident is recommended to be used for personal dental hygiene 3-5 times a week in addition to regular toothpaste.

A professional solution that patients can use at home to extend the benefits of a professional tooth cleaning.

- Whitout preservatives
- Contains sodium fluoride (1000 ppm Fluoride)
- RDA 39



Cleanicident - Toothpaste with whitening effect

REF/Part No. 3400WE

40 ml Tube

1.10 Products with Chlorhexidine

PlakACT™

Your ally in oral health!

PlakACT line is indicated for the integration into a normal hygiene routine, by preventing bacterial deposits (plaque) on the surface of the teeth and mucous membranes, keeping them in good condition. Acts as a mouthwash, oral spray or gel exactly where you want it and with the intensity you want. Its three types of applications can be used at home and in the dental practice. Inspired by proven formulations available in the Swiss market for 40 years.

PlakACT™ Gel

Gums Protection Gel – 0.2% Chlorhexidine

Whenever you want a prolonged presence and a lasting effect. PlakACT Gel is indicated for intensive anti-plaque action, in particular:

- Before and after any dental treatment including periodontal surgery
- In case of problems with periodontal and gingival tissues

PlakACT Gel is also recommended for the daily hygiene of removable prostheses and orthodontic appliances, which may lead to increased plaque accumulation and gums irritation, thus controlling the unpleasant odor sometimes caused by the devices themselves.

- Thanks to its gel formulation, it stays in place without flowing away
- It does not contain alcohol.
- It leaves a pleasant sensation of freshness in the mouth.

PlakACT Gel can be applied to the entire dental arch by using the dispenser nozzle that allows precise distribution without dispersion of the gel.



PlakACT Gel - 33g Tube



PlakACT Gel - 20x 5g Tubes

PlakACT Gel - Gums Protection Gel – 0.2% Chlorhexidine	REF/Part No.
PlakACT Gel - 33g Tube	8550
PlakACT Gel - 20x 5g Tubes	8551

PlakACT™ Spray

Oral Spray – 0.1% Chlorhexidine

For targeted applications.

PlakACT Spray is an hydroalcoholic solution indicated for the topical treatment of the mucous membrane of the mouth and particularly in all situations in which the control of plaque formation, with normal mechanical oral hygiene, is difficult or impeded (e.g. surgical interventions, teeth extractions, implants, fixed prostheses, orthodontic appliances, and patients with physical or mental disabilities).

- Excellent adjunct in the control of halitosis of dental origin and in the protection of the mucous membranes of the oral cavity.
- Easy to use and precise: the dispenser nozzle allows to target the selected area spraying the pre-dosed quantity.
- Without propellants or dyes.

PlakACT Spray – 0.1% Chlorhexidine

REF/Part No. 8560

PlakACT Spray - 50ml Bottle



PlakACT Spray - 50ml Bottle

PlakACT™ Mouthwash

Mouthwash – 0.1% Chlorhexidine

The standard application form for normal hygiene routine.

PlakACT Mouthwash is an hydroalcoholic solution and is indicated in all situations where the control of plaque formation, with normal oral hygiene, is difficult or impeded (e.g. surgical interventions, teeth extractions, implants, fixed prostheses, orthodontic appliances, and patients with physical or mental disabilities).

Excellent adjunct in the control of halitosis of dental origin and in the protection of the mucous membranes of the oral cavity.

- Without dyes.
- Ready to use with dosing cap: for easy dispensing

PlakACT Mouthwash – 0.1% Chlorhexidine

REF/Part No. 8553

PlakACT Mouthwash - 250ml Bottle



PlakACT Mouthwash - 250ml Bottle

1.11 Oral prophylaxis workflow

KaVo Kerr Propphy Box

Convenient prophyl solutions in one box

The KaVo Kerr Propphy Box contains a KaVo SMARTmatic prophylaxis instrument and complementary Kerr consumables to offer a comprehensive package based on the needs of each practice.

By combining the undisputed quality of the number 1 handpiece manufacturer, KaVo, with the strong heritage and materials knowledge that define Kerr, the German market leader in prophyl pastes, dental practitioners can now experience peace of mind and efficiency from a single source.

With proven solutions designed to perfectly complement each other, you can rest assured that the combination of KaVo technology and Kerr consumables will always inspire you.

Products included in the bundles:

- Kerr OptiView – Lip and cheek retractor
- KaVo SMARTmatic – Prophylaxis contra-angles
- Kerr Cleanic – One-step polishing paste
- Kerr Propphy-Clips
- Kerr Pro-Cups, Propphy Cups or PerfectPearl prophyl angles



Propphy Box SMARTmatic	REF/Part No.
Propphy Box SMARTmatic PROPHY S31 - Screw-type	7500 BUN
Propphy Box SMARTmatic PROPHY S33 - Snap-on	7501 BUN
Propphy Box SMARTmatic S53 - Latch type	7502 BUN
Propphy Box SMARTmatic S19 - Propphy Angles	7503 BUN

1.12 Prophy pastes

Cleanic™ in Tube

One-Step cleaning and polishing paste with perlite

Cleanic™ is the proven one-Step cleaning and polishing paste with integrated cleaning variability: during the initial seconds of use, the paste exerts a high cleaning power that converts into a gentle polishing action as the Perlite particles fragment.

This technology makes Cleanic a unique paste that combines high cleaning power, polishing of dental surfaces and gentleness on hard tissue. Cleanic is a paste for dental hard substances which may also be used on all denture materials. It features an RDA of 21 and is not made with gluten and lactose. Cleanic is available in five versions – Mint (with and without fluoride), Green Apple, Berry Burst and in a variant free of artificial colours and flavours.

Cleanic is offered in three different types of packaging: single dose, tube and jar



Integrated abrasion variability

The volcanic perlite (natural silica) particles adapt their abrasiveness throughout your procedure.

Cleaning

When Cleanic is first applied to the tooth surface, it behaves like a coarse paste. This is when Cleanic's cleaning ability is in full force.

Polishing

Under load and within seconds, the abrasive particles are fractionated and their cutting edges become rounded and less blunt. At this point, the paste becomes effective for high-gloss polishing.

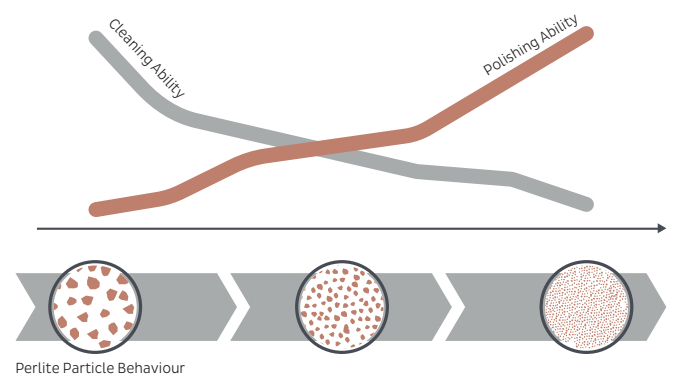

Cleanic™ in Tube – 100 g	REF/Part No.
Cleanic in Tube – Mint – With fluoride	3380
Cleanic in Tube – Green Apple – With fluoride – Without menthol	3382
Cleanic in Tube – Berry Burst – With fluoride	3386
Cleanic in Tube – Light – With fluoride – Without artificial colourants and flavouring	3384
Cleanic in Tube – Mint – Without fluoride	3183

Cleanic™ in Jar and Single Doses

One-Step cleaning and polishing paste with perlite

Cleanic™ in Jar Refill Packs REF/Part No.

Cleanic in Jar – With fluoride – 200 g	3310
Cleanic in Jar – With fluoride – 100 g	3330
Cleanic in Jar – Without fluoride – 200 g	3210
Cleanic in Jar – without fluoride – 100 g	3230

Cleanic™ Single Dose REF/Part No. 3340

With fluoride – 200 individual portions (2g), 3 Ring Pots.



Cleanic in Jar



Cleanic Single Dose

CleanPolish™ and SuperPolish™

Pastes containing pumice

CleanPolish is a cleaning prophy paste for cleaning natural teeth and metal fillings quickly, easily and effectively. It contains pumice as abrasive and it features an RDA value of 43.8.

SuperPolish is a paste for polishing both natural teeth and metal fillings. It contains alumina as abrasive and it features an RDA of 9.8. By using SuperPolish as the second step of a complete cleaning and polishing procedure delivers visual results which will impress even the most demanding patients and professionals.

Both CleanPolish and SuperPolish are without fluoride and anise flavoured. Not made with Gluten and Lactose.

CleanPolish™ REF/Part No. 360

50 g paste – Anise flavour – Without fluoride

SuperPolish™ REF/Part No. 361

45 g paste – Anise flavour – Without fluoride



CleanPolish™



SuperPolish™

Paste Carriers

Available as single use or multiple use, these ergonomic prophy paste carriers are easy to fit to your finger, and have enough space/volume even for bigger amounts of paste (when/if needed).

Ring Pots - Not autoclavable REF/Part No.

Ring Pots – Blue – Pack of 100	985
Ring Pots – Assorted Colours – Pack of 100	986

Prophy-Clips™ - Autoclavable REF/Part No.

Prophy-Clips – Pack of 6	3151
--------------------------	------



Prophy-Clips™

1.13 Cleaning and Polishing Cups and Brushes

PerfectPearl™

Disposable prophylaxis angles

Designed with a hygienist's needs in mind, the PerfectPearl™ disposable prophylaxis angle was manufactured with the patented Pro-cup design. In addition to the exceptional interproximal access provided by the contra angle, the lip of the cup delivers a nice flare for optimal subgingival cleaning.

The spiral grooves on the inside of the patented cup design holds the prophylaxis paste and pushes it towards the tooth as the prophylaxis angle rotates, reducing splatter. In turn, the spiral grooves on the outside of the cup allow the use of both the inside and the outside of the cup to polish, which helps increase efficiency and may decrease chair-side time. Choice of soft or standard cups.

Not made with natural rubber latex.



PerfectPearl™ Classic - Soft Cup



PerfectPearl™ Midnight - Standard Cup











PerfectPearl	REF/Part No.
PerfectPearl Classic - Soft Cup - Pack of 144	1820
PerfectPearl Midnight - Standard Cup - Pack of 144	1821

Pro-Cup™ & Pro-Cup™ Junior

Prophy cups

The patented Pro-Cup™ range allows the economical, splash-free application of prophy paste. The lamellar inner and outer profile drives the prophy paste and saliva towards the edge of the cup on a helical principle, minimising splatter. Pro-Cup offers the optimal cleaning and polishing tool whatever the clinical situation and clinician's preferences.

Pro-Cup is not made with natural rubber latex.

Pro-Cup™ — Soft		REF/Part No.
	Screw-type	Pack of 120
		Pack of 30
	Latch-type	Pack of 120
		Pack of 30
Pro-Cup™ — Hard		REF/Part No.
	Screw-type	Pack of 120
		Pack of 30
	Latch-type	Pack of 120
		Pack of 30
Pro-Cup™ Junior — Soft		REF/Part No.
	Screw-type	Pack of 120
		Pack of 30
	Latch-type	Pack of 120
		Pack of 30
Pro-Cup™ Junior — Hard		REF/Part No.
	Screw-type	Pack of 30
	Latch-type	Pack of 120
		Pack of 30

Pro-Brush™

Cleaning and polishing brush

Pro-Brush™ is a superior-quality tooth cleaning and polishing brush, easily recognisable by its blue biocompatible polymer cup. This polymer cup avoids scratches or damage to the adjacent teeth surfaces when they accidentally come into contact with the cup during the cleaning and polishing procedure.

Pro-Brush — Nylon Bristles		REF/Part No.	
 Latch-type	Pack of 10	845 RA	
	Pack of 100	845/100	

Miniature Brushes

Miniature tooth cleaning and polishing brushes

The smallest form of this type of brush, the Hawe Miniature Tooth Cleaning and Polishing Brushes are designed to be fitted to a contra-angle headpiece, loaded with prophylaxis paste and then used for cleaning/polishing natural teeth as well as glass ionomer, composite or metallic fillings. Nylon brushes available.



Miniature Brushes — Nylon Bristles		REF/Part No.	
 Latch-type	Pack of 10	835 RA	
	Pack of 100	835/100	

Prophy Cups

Programme for all needs



The Prophy Cup and Brush Programme comprises cups for all needs and indications.

Snap-On Cups — Laminated		REF/Part No.	
 Soft Ochre	Pack of 30	9005/30	
	Pack of 120	9005/120	
 Firm Orange	Pack of 30	9010/30	
	Pack of 120	9010/120	

Screw-type Cups — Laminated — Latex Free		REF/Part No.	
 Soft Light Grey	Pack of 30	9001/30	
	Pack of 120	9001/120	
 Firm Dark Grey	Pack of 30	9002/30	
	Pack of 120	9002/120	

Snap-On Mandrel for all Snap-On Brushes and Snap-On Cups		REF/Part No.	
 Latch-type	Pack of 3	976	
	Pack of 10	976/10	



Screw-type Cups — Ribbed — Latex Free		REF/Part No.	
 Soft Turquoise	Pack of 30	9000/30	
	Pack of 120	9000/120	

Latch-type Cups — Ribbed		REF/Part No.	
 Soft Pink	Pack of 30	9007/30	
 Firm Magenta	Pack of 30	9008/30	

Screw-type Cups — Point		REF/Part No.	
 Soft Peach	Pack of 30	9003/30	

Latch-type Cups — With Brushes — Natural Bristles*		REF/Part No.	
 Firm White	Pack of 30	9009/30	

Screw-type Cups — Spiral — Latex Free		REF/Part No.	
 Soft Violet	Pack of 30	9004/30	

Latch-type Cups — Laminated		REF/Part No.	
 Soft Light Green	Pack of 30	9006/30	
	Pack of 120	9006/120	
 Firm Forest Green	Pack of 30	9011/30	
	Pack of 120	9011/120	

Screw-Type Mandrel for all screw-type products to latch-type		REF/Part No.	
 Latch-Type	pack of 10	1301	

1.14 Implant prophylaxis

Implant Deplaquers

Dental implant deplaquers

Implant Deplaquer instruments are made of carbon-fibre reinforced plastic material, with sufficient strength to remove plaque and soft deposits from the implant neck while minimising scratches on metal surfaces. Available in two shapes:

- **Universal:** Allows the topical reach of all surfaces
- **Orofacial:** Allows the reach of lateral sides with more surface available

Implant Deplaquers Refills	REF/Part No.
Universal Implant Deplaquers, Pack of 5	1350
Universal Implant Deplaquers, Pack of 2	1351
Orofacial Implant Deplaquers, Pack of 5	1360
Orofacial Implant Deplaquers, Pack of 2	1361



Universal Implant Deplaquer



Orofacial Implant Deplaquer

Implant Paste

Paste containing aluminium oxide

This special prophylaxis paste has been developed for the efficient and gentle maintenance of implants. With a pleasant, fresh mint taste, this fluoride-free, pumice-free paste is ideal for application following the use of implant deplaquers to eliminate bio-film deposits. The selected formulation and the low RDA of 10 enables regular cleaning of the implant surface without scratching it, contributing to its longevity. Implant Paste works with any type of cup and brush.

Implant Paste	REF/Part No. 3500
45g paste — Peppermint flavour — Without fluoride	



Implant Paste

1.15 Lip retractor and trays

OptiView™

Lip and cheek retractor

The innovative OptiView™ provides retraction of lips and cheeks for improved buccal and gingival access at the same time. It facilitates both lip and cheek retraction with one device without the need for additional hands or instruments. Owing to its anatomic shape, OptiView minimises tension, offering the patient greater comfort even during longer dental treatments. Frames and cushions are autoclavable at 134 °C, at least 3 min. Available in 2 sizes, for smaller or normal mouths. Particularly indicated for patients reacting with panic and claustrophobia, strong nausea or strong lip pressure, and in general for children and elderly and patients with special requirements.

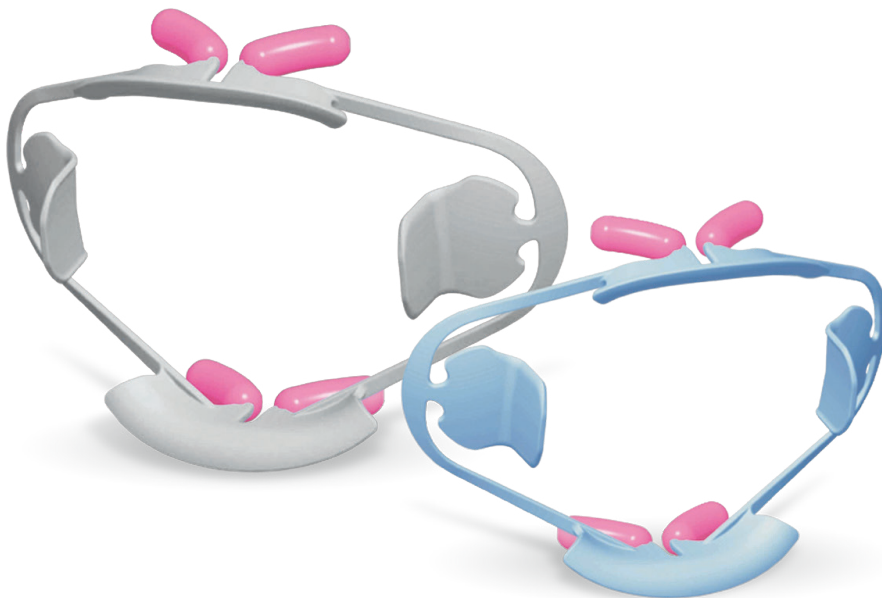

Enjoy the unobstructed view

Dual purpose: permits both lip and cheek retraction with one device, without additional hands or instruments

Uniform perioral retraction: maximises visibility and access to the working field

Passive placement: stable, flexible 3D design, ensures quick and gentle placement and removal, facilitating the placement of the saliva ejector

Cushioned lip supports: enhance patient comfort during longer procedures

Not made with natural rubber and autoclavable at 134 °C for 3 minutes

Available in two sizes: standard (white) and small (light blue)

OptiView Standard Kit

REF/Part No. 5500

2 standard lip and cheek retractors with mounted cushions

OptiView Small Kit

REF/Part No. 5502

2 small lip and cheek retractors with mounted cushions

OptiView Cushions Refills

REF/Part No. 5501

10 OptiView Refill cushions

Standard

104 mm

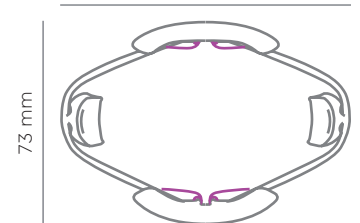

Small

97 mm

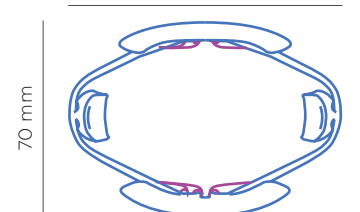

Discovery Trays

For topical fluoride application

Patented disposable trays for topical fluoride application, designed for patient fit and comfort. The foam matrix ensures fluoride coverage to all tooth surfaces without a separate insert and the tray construction permits simultaneous fluoride application to both maxillary and mandibular arches.

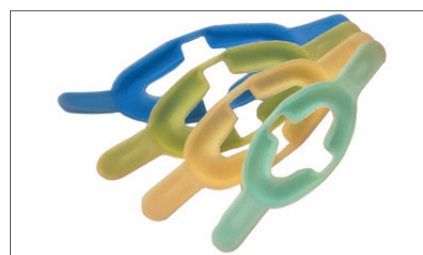

Discovery Trays

Discovery Trays — Child (Aqua)	REF/Part No.
Standard Pack of 30	14202
Bulk Pack of 100	16188

Discovery Trays — Small (Yellow)	REF/Part No.
Standard Pack of 30	14199
Bulk Pack of 100	16189

Discovery Trays — Medium (Lime)	REF/Part No.
Standard Pack of 30	14200
Bulk Pack of 100	16190

Discovery Trays — Large (Blue)	REF/Part No.
Standard Pack of 30	14201
Bulk Pack of 100	16191

Endoragard™

Tooth protector

Endoragard tooth protector prevents the loosening and fracture of anterior teeth during orotracheal intubation, laryngoscopy and endoscopy.

Endoragard — Disposable Tooth Protector	REF/Part No. 24520DX
Endoragard — Pack of 50	



Endoragard

1.16 Instrument reprocessing

PeelVue+™

Sterilisation pouches

PeelVue+™ are preformed autoclave and chemiclave sterilisation pouches. They feature patented internal multi-parameter indicators and patented “Closure Validators”. “Closure Validators” provide a guide for creating a proper seal and keep contaminants out. Built-in indicators provide a visual confirmation when the sterilisation process is completed.

- Easy-to-peel and -seal application
- Lead-free inks on medical-grade, non-recycled paper
- Clear film for good visibility of instruments and indicators
- Available in different sizes, all colour-coded for immediate identification



PeelVue+ — Autoclave/Chemiclave Pouch with Multi-parameter Chemical Indicators					
REF/Part No.			External size (mm)	Internal effective size (mm)	Suggested for
Case of 5 Boxes	Case of 10 Boxes				
	31620	Implants, rubber dam clamps	90 x 135	70 x 80	
	31621	Handpieces, hand instruments	70 x 230	50 x 170	
	31622	Handpieces, hand instruments	90 x 230	65 x 170	
	31623	Burs	55 x 100	35 x 50	
	31624	Impression trays, bur blocks	135 x 165	115 x 110	
31625		Multiple instruments and cassettes	215 x 380	195 x 290	
	31626	Long hand instruments	85 x 305	60 x 210	
	31627	Surgical and orthodontic instruments	108 x 305	85 x 210	
31628		Multiple instruments, small cassettes	205 x 305	185 x 210	
	31629	Multiple instruments	135 x 305	110 x 210	
31653		Large cassettes	267 x 406	245 x 325	
31657DX		Large cassettes (I.M.S. type)	337 x 508	310 x 425	

EmPower™ Fragrance Free

Enzymatic cleaning concentrate

EmPower™ Fragrance Free is a low-foaming dual enzymatic cleaning concentrate designed for instrument reprocessing in dental washer disinfectors. The dual enzymatic formulation is highly effective in removing organic bio-burden including blood tissue, mucous or protein-rich fluids, while leaving instruments and equipment clean and shiny. Its pH-neutral formulation makes it uniquely suited for the removal of bio-film from within the hoses of aspirating units.

EmPower™ Fragrance Free REF/Part No. 10-4700



EmPower Fragrance Free

1.17 Dental office organisation

S Tubs

S Tubs are portable drawers that can be used with procedure tray set-ups, to organise, store and transport support materials with ease. Made of sturdy plastic, each dental tub can be auto/chemiclaved.



S Tubs

S tubs - 238 x 292 x 57 mm, with a 19 mm Lip	REF/Part No.
S Tubs — French Vanilla	31950
S Tubs — Sea Foam	31965
S Tubs — Lilac	31970DX
S Tubs — Baby Blue	31975DX

S Tub Lid

The S Tub Lid is a highly durable, transparent barrier that protects against airborne contaminants. The elevated design increases tub storage capacity and accommodates taller items. This S Tub Lids are specifically designed to fit Kerr's S Tubs.

S Tub Lid	REF/Part No. 31526DX
S Tub Lid — 330 x 279 x 38mm	

S Tub Dividers

The plastic S Tub Dividers fit together to form compartments, and can easily be adapted to a dental office's needs. The tubs are designed to complement the S Tubs.

S Tub Dividers	REF/Part No. 31940
S Tub Dividers — 3.81cm in height	

S Tub Divided Insert

Compartmentalised insert to fit the S Tubs. Made of sturdy auto/chemiclavable plastic, S Tub Divided Inserts afford extra convenience during use in the dental office.

S Tub Divided Insert	REF/Part No. 31990DX
S Tub Divided Insert — 290 x 235 x 28.5mm	

Side Loading Tub Racks

Kerr Side Loading Tub Racks are free-standing racks made of sturdy chromed steel. The Tub Racks can accommodate 4 S, CC or Mini Tubs, or can hold 3 tubs with lids, and are easy-to-assemble without tools.

Side Loading Tub Racks

REF/Part No. 31580DX

Side Loading Tub Rack — 335 x 250 x 360 mm (minimum cabinet depth: 33.34 cm)



Side Loading Tub Racks

Trays

Kerr dental trays are made of sturdy polypropylene auto/chemiclavable plastic, meaning they are easy-to-clean and disinfect. Available in 2 sizes in 5 different colours, the trays can be cleaned and sterilised as a set or separately.

B Trays Flat — 340 x 240 x 22 mm

REF/Part No.

B Trays Flat — White	31122
B Trays Flat — French Vanilla	32125
B Trays Flat — Sea Foam	32128
B Trays Flat — Lilac	32129
B Trays Flat — Baby Blue	32130

F Mini Trays Flat — 242 x 170 x 22 mm

REF/Part No.

F Mini Trays Flat — White	31142DX
F Mini Trays Flat — French Vanilla	32144
F Mini Trays Flat — Sea Foam	32147
F Mini Trays Flat — Baby Blue	32149
F Mini Trays Flat — Lilac	32148



B Trays Flat



F Mini Trays Flat

Tray Racks

Each dental tray rack is made of sturdy chromed steel and can be assembled without tools.

Tray Rack Size F (Mini)

REF/Part No. 31304DX

Short Side Loading - Use for 8 Size F Mini dental trays (minimum cabinet space: 190x250x360mm)

Tray Rack Size B

REF/Part No. 31312DX

Short Side Loading - Use for 8 Size B dental trays (minimum cabinet space: 275 x 350 x 360 mm)



Tray Racks

Bur Blocks

Magnetic, colourful and accessible storage for all types of rotary cutting instruments.

- Made of resistant polypropylene plastic.
- Suitable for ultrasonic cleaning, autoclavable.
- Accept all shank sizes: right angle, friction grip, and handpiece.
- Three capacities: 8, 14, or 24 burs.

Bur Block — 8-Holes — Round — 40 mm diameter	REF/Part No.
Bur Block 8-Holes — White	31002DX
Bur Block 8-Holes — French Vanilla	31820DX
Bur Block 8-Holes — Sea Foam	31823DX
Bur Block 8-Holes — Lilac	31824DX
Bur Block 8-Holes — Baby Blue	31825DX

Bur Block — 24-Holes — Round — 70 mm diameter	REF/Part No.
Bur Block 24-Holes — White	31007DX
Bur Block 24-Holes — Lilac	31834DX
Bur Block 24-Holes — Baby Blue	31835DX

Bur Block — 14-Holes — Rectangular	REF/Part No.
Bur Block 14-Holes — White	31801
Bur Block 14-Holes — Lilac	31817
Bur Block 14-Holes — Baby Blue	31818DX

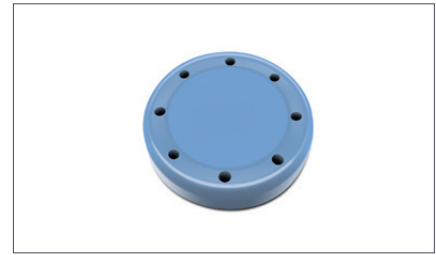

Bur Block 8-Holes

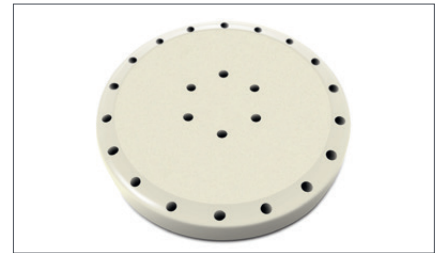

Bur Block 24-Holes

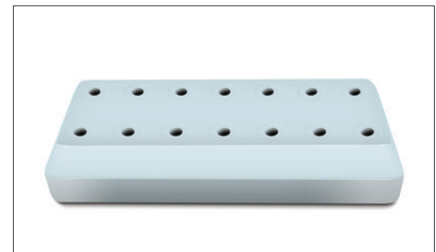

Bur Block 14-Holes

Preserve what matters — comfortably

Kerr Endodontics is behind some of the most defining products in the field, from the long-established K-File to the slick and intuitive elements™IC obturation system.

Lack of visibility of the working area, unknown variables it is difficult to plan for, and a wealth of techniques and solutions available – all claiming to be the best performing of all – are only a few of the challenges regularly faced by professionals in the field.

With a focus on giving you control, flexibility and outcome predictability, our complete range of root canal treatment solutions enables you to perform at your best, from patient preparation and diagnosis all the way to obturation.

Kerr Endodontics strikes the perfect balance between offering intuitive solutions to empower general practitioners to undertake complex treatments with confidence, and sophisticated technology to appeal to even the most specialised endodontists.



Simplifying complex procedures

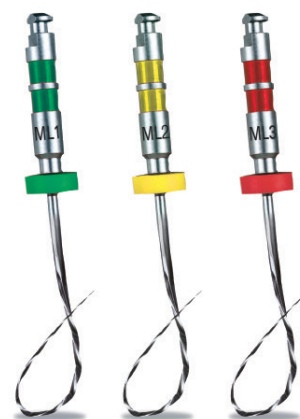

Kerr Endodontics is committed to helping endodontists and general practitioners to achieve their goals without adding unnecessary complications to the already challenging reality of root canal treatments.

Each solution makes the best use of intuitive and user-friendly features — such as colour-coded file identification, wireless and intuitive technology and 360 degree activation rings — freeing your minds from doubts and helping to reduce the risks of errors.

A focus on precision technology facilitates safe and easy navigation of the entire root canal, while giving you the control you need to perform each step to the best of your ability: from excellent apex location identification during diagnosis, to complete working length accessibility during shaping, cleaning and filling.

2.1 Patient preparation

OptiDam™

3D rubber dental dam

OptiDam™ is the first rubber dam with a 3-dimensional shape and nipple design, for practical and easy application. The dental dam, combined with its dedicated anatomical frame, matches the contours of the mouth, giving perfect visibility and accessibility to the treatment area. It does all this while ensuring the patient is comfortable throughout the procedure.

Available in two versions – anterior and posterior, it offers optimum protection for both patient and dental staff.

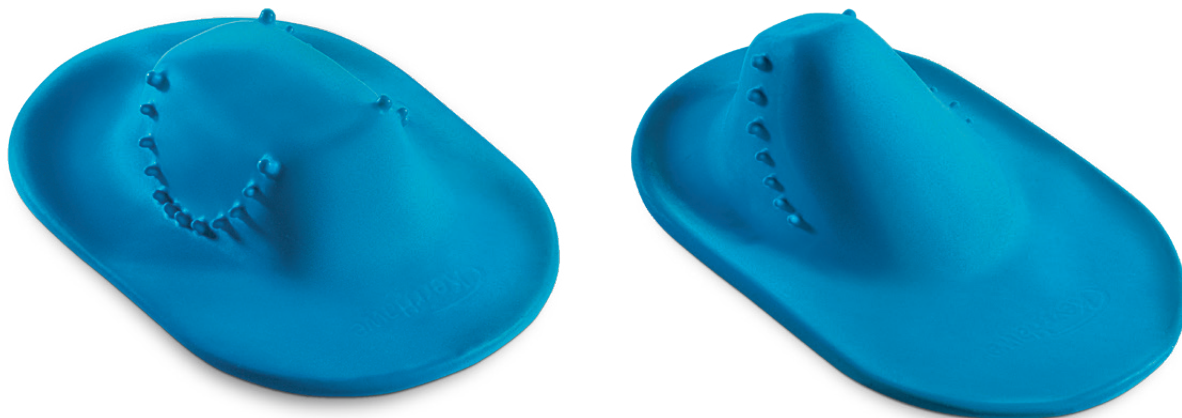

OptiDam – Posterior Intro Kit REF/Part No. 5200

10x Posterior OptiDam 3D Rubber Dam, 1x Anatomical Frame

OptiDam – Anterior Intro Kit REF/Part No. 5203

10x Anterior OptiDam 3D Rubber Dam, 1x Anatomical Frame

OptiDam – Refills REF/Part No.

OptiDam – Frame Refill - Pack of 2	5202
OptiDam – Posterior Refill - Pack of 30	5201
OptiDam – Anterior Refill - Pack of 30	5204
OptiDam – Posterior Refill - Pack of 60	5205
OptiDam – Anterior Refill - Pack of 60	5206

2.2 Diagnosis

Apex ID™

Digital apex locator

The Apex ID™ is compact and modern with unique functions that allow you to focus on what's important; providing the best care for your patients. It has been designed to work in almost any canal condition: dry, wet, bleeding or filled with saline, EDTA, NaOCl or chlorhexidine.

- Possible to adapt the “point zero” and sound signals for a more intuitive use
- Accuracy of measurements in all root canal conditions for precise information
- Unstopped readings in real time for increased precision



User-set zero point

Customise the “point zero” based on your clinical judgment. No need to constantly monitor the visual display, the audible signal will let you know when you've reached your preferred zero point.

Accuracy in almost any condition

Apex ID has been designed to work in almost any canal condition. Whether dry, wet, bleeding, filled with saline, EDTA, NaOCl or chlorhexidine, the Apex ID can still provide accurate, consistent and dependable readings.

Continuous calibration

Unlike most locators on the market today, Apex ID continuously calibrates for accurate, uninterrupted readings in real time.

Apex ID™ — Starter Kit

REF/Part No. 972-0090

1x Apex ID, 1x Apex ID Stand, 5x Lip Hooks, 2x File Clips,
1x File Probe, 1x Probe Cord, 1x Apex ID IFU, 3x AAA 1.5 V Batteries

Apex ID™ — Accessories

REF/Part No.

Apex ID — Lip Hooks - Pack of 5	972-0092
Apex ID — File Clips - Pack of 2	972-0093
Apex ID — File Probe	972-0094
Apex ID — Probe Cord	972-0095

2.3 Shaping

TF™ Adaptive System

NiTi endo file system

TF™ Adaptive is the unique endodontic file system with Adaptive Motion Technology, which adjusts to intra-canal torsional forces depending on the amount of pressure placed on the file. This means the file is in either a rotary or reciprocation motion depending on the situation. The result is exceptional debris removal with our classic rotary Twisted File design and less chance of file pull-in. TF Adaptive gives exceptional file control through the entire procedure.



TF Adaptive procedure

Small canals

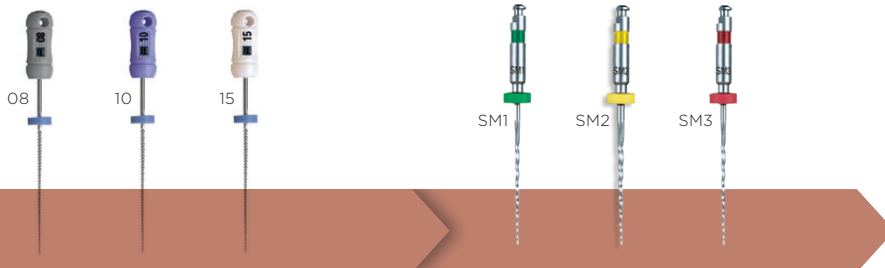

Step 1

K-File hand files

Step 2

TF Adaptive files SM

Medium/large canals

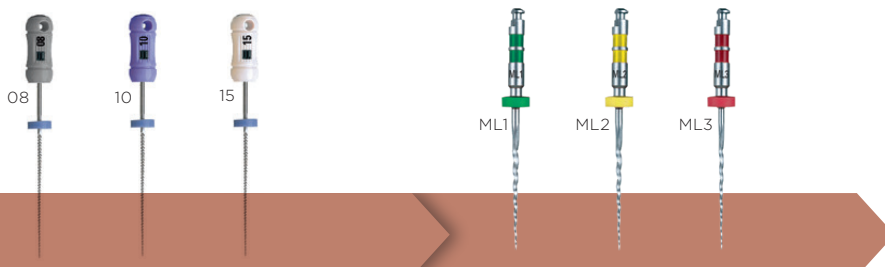

Step 1

K-File hand files

Step 2

TF Adaptive files ML

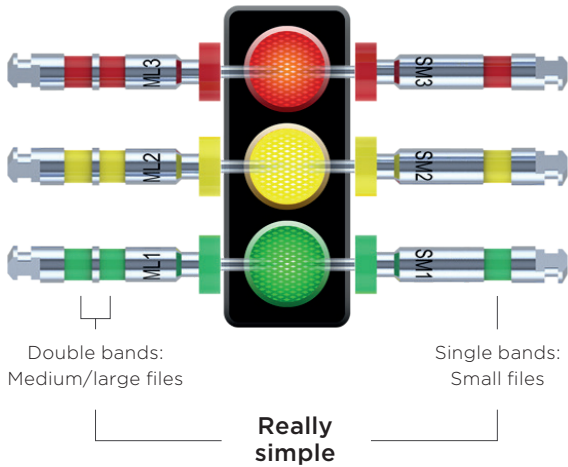

Intuitive file identification

An intuitive, colour-coded system designed for efficiency and ease of use. Just like a traffic light ... start with green and stop with red.

Study of apical debris extrusion*

Compared with the TF Adaptive System, the Manual Step-Back technique generated 207% more debris from the apex than TF Adaptive while Wave One generated 59% more debris from the apex than TF Adaptive.

* Jaramillo, D. and Raydolfo, A. (2013) Comparison of the Extrusion of Dentine Debris Using a New Instrumentation. Publication pending.

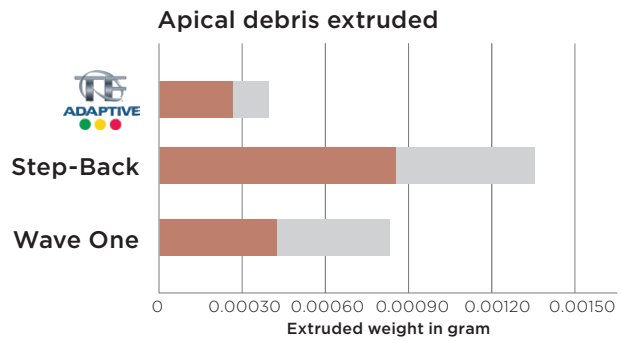

Adaptive Motion Technology

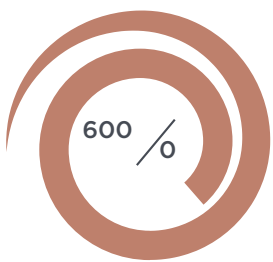

Rotary

600° clockwise and 0° counter-clockwise. file motion when no load is applied.

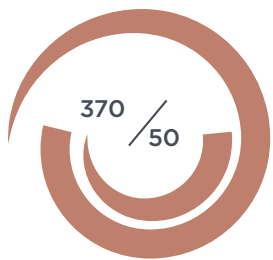

Reciprocation

370° clockwise and up to 50° counterclockwise file motion when load is applied.

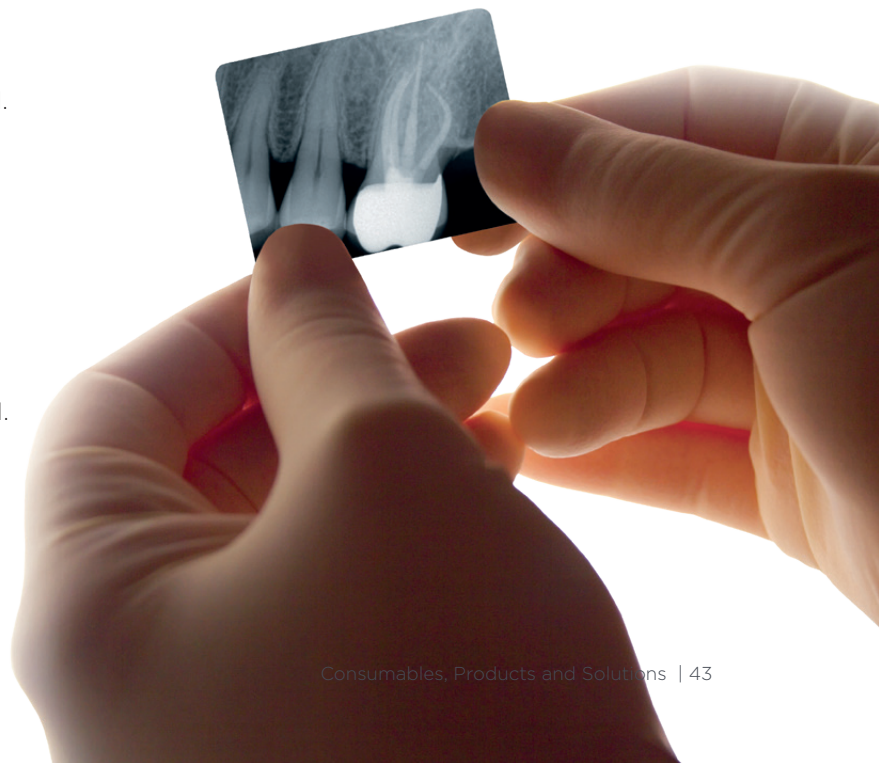

elements™ e-motion

Endodontic motor with Adaptive Motion

The new KaVo Kerr elements e-motion provides efficiency and safety. The improved Adaptive Motion offers higher cutting efficiency and the new maximal torque limitation provides a better ability to resist breakage or deformation of the file.

KaVo Kerr elements e-motion was completely designed and manufactured in Germany and has a stainless steel handpiece powered by KaVo. It is intuitive to use, due to a user-friendly, coloured touchscreen and an interface that allows 5 fully customisable presets with up to 10 file options each.

- The file system has more than 190 preset files
- Ease of adding new files, customising names, sizes, rpm and torque
- 4 mounting options for handpiece holder
- System includes controller, motor and 8:1 handpiece. System speed 20–2.500 rpm and torque 0.1–6.0 Ncm
- 12-month warranty





Streamlined Workflow

The intuitive, full-colour touchscreen allows easy access to your preferred pre-sets. Customise your preset with 24 file systems in the database.

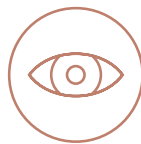

Better Visibility and Access

Smaller head for better visibility and easier posterior access.



Smart Technology

Smart algorithm enables higher cutting efficiency and greater protection against breakage and deformation.



Ergonomic Design

Whether you're right-handed or left-handed, elements e-motion includes 4 handpiece mounting options to meet your needs.

elements™ e-motion	REF/Part No.
elements e-motion EU	815-1701
elements e-motion UK	815-1703
elements e-motion EE	815-1702
elements e-motion MEA	815-1706
elements e-motion NE	815-1707

elements™ e-motion — Accessories	REF/Part No.
elements 8:1 handpiece	815-1655
elements e-motion — Power supply	815-1721
elements e-motion — Power cable EU	815-1712
elements e-motion — Power cable UK	815-1713
elements e-motion — Foot control	815-1720
elements e-motion — Motor cord	815-1722

TF Adaptive Files

NiTi twisted files

The TF Adaptive File design is based on our clinically proven Twisted File technology, which means the file is twisted to shape for improved file durability, features R-Phase™ Technology to improve file flexibility and provides exceptional debris removal.

An intuitive, colour-coded system designed for efficiency and ease of use. Just like a traffic light ... start with green and stop with red.



TF Adaptive Files

TF™ Adaptive Files	REF/Part No.
TF Adaptive File SM1 23mm (4 pcs)	817-4203
TF Adaptive File SM1 27mm (4 pcs)	817-4207
TF Adaptive File SM2 23mm (4 pcs)	817-6253
TF Adaptive File SM2 27mm (4 pcs)	817-6257
TF Adaptive File SM3 23mm (4 pcs)	817-4353
TF Adaptive File SM3 27mm (4 pcs)	817-4357
TF Adaptive File ML1 23mm (4 pcs)	817-8253
TF Adaptive File ML1 27mm (4 pcs)	817-8257
TF Adaptive File ML2 23mm (4 pcs)	817-6353
TF Adaptive File ML2 27mm (4 pcs)	817-6357
TF Adaptive File ML3 23mm (4 pcs)	817-4503
TF Adaptive File ML3 27mm (4 pcs)	817-4507

TF™ Adaptive Files	REF/Part No.
Small Procedure Pack 23mm	817-3003
Small Procedure Pack 27mm	817-3007
Med/Lrg Procedure Pack 23mm	817-4003
Med/Lrg Procedure Pack 27mm	817-4007



TF Adaptive Paper Points

TF Adaptive Paper Points	REF/Part No.
TF Adaptive Paper Points - Small Yellow Pack - SM2 - Pack of 100	815-1570
TF Adaptive Paper Points - Small Red Pack - SM3 - Pack of 100	815-1571
TF Adaptive Paper Points - Small Asst Pack - SM2, SM3 - Pack of 100	815-1575
TF Adaptive Paper Points - Medium/Large Green Pack - ML1 - Pack of 100	815-1572
TF Adaptive Paper Points - Medium/Large Yellow Pack - ML2 - Pack of 100	815-1573
TF Adaptive Paper Points - Medium/Large Red Pack - ML3 - Pack of 100	815-1574
TF Adaptive Paper Points - Medium/Large Ass. Pack - ML1, ML2, ML3 - Pack of 100	815-1576



TF Adaptive Paper Points

TF Adaptive Gutta-Percha Point

TF Adaptive Paper Points	REF/Part No.
TF Adaptive Gutta-Percha - Small Yellow Pack - SM2 - Pack of 50	815-1540
TF Adaptive Gutta-Percha - Small Red Pack - SM3 - Pack of 50	815-1541
TF Adaptive Gutta-Percha - Small Assorted Pack - SM2, SM3 - Pack of 50	815-1542
TF Adaptive Gutta-Percha - Medium/Large - Green Pack - ML1 - Pack of 50	815-1543
TF Adaptive Gutta-Percha - Medium/Large - Yellow Pack - ML2 - Pack of 50	815-1544
TF Adaptive Gutta-Percha - Medium/Large - Red Pack - ML3 - Pack of 50	815-1545
TF Adaptive Gutta-Percha - Medium/Large Ass. Pack - ML1, ML2, ML3 - Pack of 50	815-1546



TF Adaptive Gutta-Percha

TF Adaptive Verifier

TF Adaptive Verifier	REF/Part No.
TF Adaptive Verifier - Small - Yellow Pack - SM2 - Pack of 6	815-1552
TF Adaptive Verifier - Small - Red Pack - SM3 - Pack of 6	815-1553
TF Adaptive Verifier - Medium/Large - Green Pack - ML1 - Pack of 6	815-1557
TF Adaptive Verifier - Medium/Large - Yellow Pack - ML2 - Pack of 6	815-1558
TF Adaptive Verifier - Medium/Large - Red Pack - ML3 - Pack of 6	815-1559



TF Adaptive Verifier

TF Adaptive Obturator

TF Adaptive Obturator	REF/Part No.
TF Adaptive Obturator - Small - Yellow Pack - SM2 - Pack of 6	815-1550
TF Adaptive Obturator - Small - Red Pack - SM3 - Pack of 6	815-1551
TF Adaptive Obturator - Medium/Large - Green Pack - ML1 - Pack of 6	815-1554
TF Adaptive Obturator - Medium/Large - Yellow Pack - ML2 - Pack of 6	815-1555
TF Adaptive Obturator - Medium/Large - Red Pack - ML3 - Pack of 6	815-1556



TF Adaptive Obturator

TF Adaptive Obturator — Bulk Packs	REF/Part No.
TF Adaptive Obturator - Small - Yellow Pack - SM2 - Pack of 36	815-1560
TF Adaptive Obturator - Small - Red Pack - SM3 - Pack of 36	815-1561
TF Adaptive Obturator - Medium/Large - Green Pack - ML1 - Pack of 36	815-1562
TF Adaptive Obturator - Medium/Large - Yellow Pack - ML2 - Pack of 36	815-1563
TF Adaptive Obturator - Medium/Large - Red Pack - ML3 - Pack of 36	815-1564



TF Adaptive Obturator — Bulk Pack

TF Files

3-File system

The Twisted File (TF) is the first file to combine 3 unique and proprietary processes to deliver optimal strength and flexibility:

- 1. R-Phase™ heat treatment technology:** TF is produced with Kerr Endodontics' proprietary R-Phase Technology. This patented technology is used to increase file flexibility and resistance to cyclic fatigue.
- 2. Twisted design, not ground:** Twisting helps preserve grain structure and reduces formation of microfractures, making the file even more durable.
- 3. Strength and flexibility that can be measured:** In a torsional stress comparison, Twisted Files absorbed more energy before fracture than ground blanks¹. Twisted files can withstand approximately 60% more torque than files made using a traditional manufacturing process. One study showed that Twisted Files are up to 70% more flexible than the other NiTi files tested².

¹ Nicoll T, Oestreich L, Tang C, Ravi VA. Evaluation of product properties resulting from a new NiTi endodontic file manufacturing process. Chemical and Materials Engineering Department, California State Polytechnic University, 2006.

² JOE – Volume 40, Number 11, November 2014 – Assessment of the Mechanical Properties of ProTaper Next Nickel-Titanium Rotary Files

TF Files — Procedure Pack — Anterior			
Taper	Tip	23 mm	27 mm
.08	25		
.06	30	822-3864	822-7864
.04	40		

TF Files — Procedure Pack — Posterior			
Taper	Tip	23 mm	27 mm
.08	25		
.06	25	822-3866	822-7866
.06	30		

TF Files — Small Apical Ass.		
Taper	Tip	23 mm
.08	25	
.06	30	822-8663
.06	35	

TF Files — Large Apical Ass.		
Taper	Tip	23 mm
.06	30	
.06	35	822-6643
.04	40	

TF Files — Pack of 3			
Taper	Tip	23 mm	27 mm
.12	25	822-2253	
.10	25	822-0253	822-0257
.08	25	822-8253	822-8257
.06	35	822-6353	822-6357
.06	30	822-6303	822-6307
.06	25	822-6253	822-6257
.04	50	822-4503	822-4507
.04	40	822-4403	822-4407
.04	25	822-4253	822-4257

TF Files — Small Assorted			
Taper	Tip	23 mm	27 mm
.08	25		
.06	25	822-4683	822-4687
.04	25		

TF Files — Large Assorted			
Taper	Tip	23 mm	27 mm
.10	25		
.08	25	822-6803	822-6807
.06	25		

K-Flex™ Files

Stainless steel files

K-Flex™ Files feature a unique rhomboid design, which provides a short axis for flexibility while maintaining cross-sectional strength. K-Flex is more flexible than conventional “K” files of comparable size, particularly in sizes #30 and above, which facilitates the negotiation of curved canals and their preparation with minimal potential for ledging and perforating.



K-Files™

Stainless steel files

K-Files can bypass obstructions with ease. They are designed to provide a smooth tactile feel during instrumentation.



K-Flex files — Pack of 6

Size	21 mm	25 mm	30 mm
80		15174	15258
70		15170	15254
60	15334	15166	15250
55	15330	15162	15246
50	15326	15158	15242
45	15322	15154	15238
40	15318	15150	15234
35	15314	15146	15230
30	15310	15142	15226
25	15306	15138	15222
20	15302	15134	15218
15	15298	15130	15214
10	15294	15126	15210
08	15290	15122	15206
06	60120	60144	60193

K-Files — Pack of 6

Size	21 mm	25 mm	30 mm
80		06099	06170
70	06024	06085	06166
60	06023	06077	06163
55	06022	06076	06162
50	06021	06075	06161
45	06020	06074	06160
40	06019	06069	06159
35	06016	06067	06157
30	06015	06066	06156
25	06014	06065	06155
20	06005	06064	06153
15	06004	06063	06152
10	06003	06062	06151
08	14127	14128	14129
06	62249	62250	62251

K-Files — Assorted files — Pack of 6

Size	21 mm	25 mm	30 mm
15 — 40	821-8021	821-8025	821-8030
45 — 70	61363		
45 — 80	821-8121	821-8125	821-8130

Triple-Flex Files

Stainless steel files

Triple-Flex Files are triangular-bladed, stainless steel instruments designed for flexibility with integrity. Triple-Flex Files are highly breakage resistant, even in the most stressful situations.



Hedstrom™ Files

Stainless steel files

Hedstrom Files are ground from stainless steel wire. The flute depth increases with the taper, creating a sharper, more flexible instrument.



Triple-Flex Files — Pack of 6

Size	21 mm	25 mm	30 mm
80	25941	25957	25973
70	25940	25956	25972
60	25939	25955	25971
55	25938	25954	25970
50	25937	25953	25969
45	25936	25952	25968
40	25935	25951	25967
35	25933	25949	25965
30	25932	25948	25964
25	25931	25947	25963
20	25930	25946	25962
15	25929	25945	25961
10	25928	25944	25960
08	25927	25943	25959

Hedstrom files — Pack of 6

Size	21 mm	25 mm	30 mm
80	61684	61702	61720
70	12796	11354	13278
60	12793	11353	12841
55	12790	11352	12838
50	12787	11351	12835
45	12784	11350	12832
40	12781	11349	12829
35	12778	11348	12826
30	12775	11347	12823
25	12772	11346	12820
20	12769	11345	12817
15	12766	11344	12814

Triple-Flex Files — Assorted files — Pack of 6

Size	21 mm	25 mm	30 mm
15 — 40	821-3021	821-3025	821-3030
45 — 80	821-3121	821-3125	821-3130

Hedstrom files — Assorted files — Pack of 6

Size	21 mm	25 mm	30 mm
15 — 40	12809	11359	13291
45 — 80	12810	11360	13292

Reamers

Stainless steel files

Reamers are high-quality, triangular-bladed, stainless steel instruments designed to provide flexibility with integrity.



Reamers — Pack of 6

Size	21mm	25mm	30mm
80		61412	61444
70	61378	61410	61442
60	61377	61409	61441
55	61376	61408	61440
50	61375	61407	61439
45	06040	06132	61438
40	06038	06131	61437
35	06034	06127	61435
30	06033	06126	61434
25	06032	06120	61433
20	06031	06112	61432
15	06030	06111	61431
10	06029	06110	61430
08	14133	14134	62260
06	62252	62253	62254

Reamers — Assorted files — Pack of 6

Size	21 mm	25 mm
15–40	821-2021	821-2025

K3™ Files

Nickel titanium files

K3 is a third-generation asymmetric endodontic file system. Designed to remove debris quickly, efficiently and safely.

K3 Files — Pack of 6

Taper	Tip	17 mm	21 mm	25 mm
.12	25	830-2257	830-2251	830-2255
.10	25	830-0257	830-0251	830-0255
.08	25	830-8257	830-8251	830-8255

K3 Files — Pack of 6

Taper	Tip	21 mm	25 mm	30 mm
.06	60	825-6601	825-6605	825-6600
.06	55	825-6551	825-6555	825-6550
.06	50	825-6501	825-6505	825-6500
.06	45	825-6451	825-6455	825-6450
.06	40	825-6401	825-6405	825-6400
.06	35	825-6351	825-6355	825-6350
.06	30	825-6301	825-6305	825-6300
.06	25	825-6251	825-6255	825-6250
.06	20	825-6201	825-6205	825-6200
.06	15	825-6151	825-6155	825-6150
.04	60	825-4601	825-4605	825-4600
.04	55	825-4551	825-4555	825-4550
.04	50	825-4501	825-4505	825-4500
.04	45	825-4451	825-4455	825-4450
.04	40	825-4401	825-4405	825-4400
.04	35	825-4351	825-4355	825-4350
.04	30	825-4301	825-4305	825-4300
.04	25	825-4251	825-4255	825-4250
.04	20	825-4201	825-4205	825-4200
.04	15	825-4151	825-4155	825-4150
.02	45	825-2451	825-2455	825-2450
.02	40	825-2401	825-2405	825-2400
.02	35	825-2351	825-2355	825-2350
.02	30	825-2301	825-2305	825-2300
.02	25	825-2251	825-2255	825-2250
.02	20	825-2201	825-2205	825-2200
.02	15	825-2151	825-2155	825-2150

K3 Files — Assorted — Pack of 6

Taper	Tip	21 mm	25 mm
.06	15-40	825-6021	825-6025
.04	15-40	825-4021	825-4025
.02	15-40	825-2021	825-2025

K3 Files — Procedure Packs

Taper	Tip	Length	REF/Part No.
.10	25	17 mm	830-0621
.08	25		
.06	40		
.06	35	21 mm	
.06	30		
.06	25		
.10	25	17 mm	830-0625
.08	25		
.06	40		
.06	35	25 mm	
.06	30		
.06	25		
.10	25	17 mm	830-0421
.08	25		
.04	40		
.04	35	21 mm	
.04	30		
.04	25		
.10	25	17 mm	830-0425
.08	25		
.04	40		
.04	35	25 mm	
.04	30		
.04	25		

K3 VTVT

Taper	Tip	21 mm	25 mm
.10	25	830-7721	830-7725
.08	25		
.06	35		
.04	30		
.06	25		
.04	20		

K3 G Package

Taper	Tip	Length	REF/Part No.
.12	25	17 mm	830-9921
.10	25		
.08	25		
.06	25	21 mm	
.04	25		
.02	25		
.12	25	17 mm	830-9925
.10	25		
.08	25		
.06	25	25 mm	
.04	25		
.02	25		

K3™ XF

Rotary nickel titanium files

The K3 XF rotary nickel titanium files afford flexibility and resistance to cyclic fatigue thanks to proprietary R-Phase™ Technology. K3 XF is available as a complete system with matching gutta-percha and paper point.

K3XF — Pack of 6

Taper	Tip	17 mm	21 mm	25 mm	30 mm
.12	40	823-2407	823-2401	823-2405	823-2400
.12	30	823-2307	823-2301	823-2305	823-2300
.12	25	823-2257	823-2251		
.12	20	823-2207	823-2201	823-2205	823-2200
.10	40	823-0407	823-0401	823-0405	823-0400
.10	30	823-0307	823-0301	823-0305	823-0300
.10	25	823-0257	823-0251	823-0255	823-0250
.10	20	823-0207	823-0201	823-0205	823-0200
.08	40	823-8407	823-8401	823-8405	823-8400
.08	30	823-8307	823-8301	823-8305	823-8300
.08	25	823-8257	823-8251	823-8255	823-8250
.08	20	823-8207	823-8201	823-8205	823-8200

K3XF — Pack of 6

Taper	Tip	21 mm	25 mm	30 mm
.06	60	823-6601	823-6605	823-6600
.06	55	823-6551	823-6555	823-6550
.06	50	823-6501	823-6505	823-6500
.06	45	823-6451	823-6455	823-6450
.06	40	823-6401	823-6405	823-6400
.06	35	823-6351	823-6355	823-6350
.06	30	823-6301	823-6305	823-6300
.06	25	823-6251	823-6255	823-6250
.06	20	823-6201	823-6205	823-6200
.06	15		823-6155	823-6150
.04	60	823-4601	823-4605	823-4600
.04	55	823-4551	823-4555	823-4550
.04	50	823-4501	823-4505	823-4500
.04	45	823-4451	823-4455	823-4450
.04	40	823-4401	823-4405	823-4400
.04	35	823-4351	823-4355	823-4350
.04	30	823-4301	823-4305	823-4300
.04	25	823-4251	823-4255	823-4250
.04	20	823-4201	823-4205	823-4200
.04	15		823-4155	823-4150

K3XF — Assorted — Pack of 6

Taper	Tip	21 mm	25 mm
.06	15-40	823-6021	823-6025
.04	15-40	823-4021	823-4025

K3XF — Procedure Packs

Taper	Tip	Length	REF/Part No.
.10	25	17 mm	823-0625
.08	25		
.06	40	25 mm	
.06	35		
.06	30		
.06	25	17 mm	
.10	25		
.08	25		
.04	40	25 mm	823-0425
.04	35		
.04	30		
.04	25		

K3XF G Package

Taper	Tip	Length	REF/Part No.
.12	25	17 mm	823-9925
.10	25	25 mm	
.08	25		
.06	25		
.04	25		
.02	25		

2.4 Irrigation

Irrigation Probe

Irrigation needles

Irrigation Probes are irrigation needles with a side opening and rounded tips, designed for gentle, professional irrigation of root canals, wounds and periodontal pockets without the risk of apex perforation or tissue damage.



Irrigation Probe

Irrigation Probe — Refills	REF/Part No.
Gauge No. 21 Ø 0.8 mm Green (0.8 mm x 25 mm), 40 pcs	0502
Gauge No. 23 Ø 0.6 mm Blue (0.6 mm x 25 mm), 40 pcs	0503
Gauge No. 25 Ø 0.5 mm Orange (0.5 mm x 25 mm), 40 pcs	0504
Gauge No. 30 Ø 0.3 mm Yellow (0.3 mm x 25 mm), 40 pcs	0505

2.5 Obturation/fill

elements™IC

Cordless Obturation System

The cordless elements™IC is the latest complete and reliable obturation system that combines a Downpack heat source with a Backfill extruder. Get excellent, predictable results faster and easier: rely on its longer lasting battery (compared to elementsfree, Data on File), inductive charging, and a comfortable, ergonomic design.

- **Easy to use**
feel free and comfortable without wires
- **Ergonomic**
comfortable and balanced grip
- **Inductive Charging**
no electrical connectors between handpieces and base
- **At least 16 canals on a single charge of the Backfill**
at device default temperature, using recommended settings¹
- **3D fill**
high-quality 3D obturation of the root canal system
- **Less idle time thanks to faster extrusion²**
control how fast you want the Gutta Percha to flow out of the cartridge
- **Compatible with most common cleaning solutions**
handpieces are easy to clean with no electronic connections
- **Full charge less than 3 hrs**
get ready faster
- **Easy to replace battery**
control your battery with a simple and fast operation



1. more than double compared to elementsfree, Data on File

2. Compared to elementsfree, Data on File

elements™IC — EU / Type F	REF/Part No.
elementsIC — Obturation System (EU)	973-0600-TYPEF
elementsIC — Downpack Unit (EU)	973-0602-TYPEF
elementsIC — Backfill Unit (EU)	973-0604-TYPEF

elements™IC — UK / Type G	REF/Part No.
elementsIC — Obturation System (UK)	973-0600-TYPEG
elementsIC — Downpack Unit (UK)	973-0602-TYPEG
elementsIC — Backfill Unit (UK)	973-0604-TYPEG

elements™IC — Accessories and Spares	REF/Part No.
elementsIC — Dual Charger	973-0610
elementsIC — Single Charger	973-0612
elementsIC — Transformer	973-0615
elementsIC — Power Cord, Type F (EU)	973-0616-TYPEF
elementsIC — Power Cord, Type G (UK)	973-0616-TYPEG
elementsIC — Battery	973-0620
Buchanan Heat Pluggers (XF, F, FM, M, ML)	952-0003
Buchanan Heat Plugger Fine .06 Taper	952-0004
Buchanan Heat Plugger Fine Medium .08 Taper	952-0005
Buchanan Heat Plugger Medium .10 Taper	952-0006
Buchanan Heat Plugger Medium/Large .12 Taper	952-0007
Buchanan Heat Plugger Extra Fine .04 Taper	973-0612

Elements™ Gutta Percha Cartridges

Innovative Gutta Percha cartridges

Compatible with the Elements Obturation and elements™free systems, each cartridge contains enough gutta percha to fill up to four canals. The specially designed, highly durable needle can be pre-bent to fit the patient's canal anatomy. Moreover, being 5 mm longer gives the user greater ability to reach the working length of the canal.

The unique copper and gold plating conducts heat more efficiently, reducing the risk of the gutta-percha losing heat as it passes through the needle and into the canal chamber.

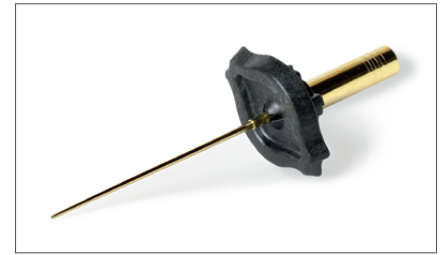

Elements Gutta Percha Cartridge

Elements™ Gutta Percha Cartridges	REF/Part No.
Elements Gutta Percha Cartridge Medium 23GA — Pack of 10	972-2500
Elements Gutta Percha Cartridge Light 25GA — Pack of 10	972-2501
Elements Gutta Percha Cartridge Heavy 23GA — Pack of 10	972-2502
Elements Gutta Percha Cartridge 23GA (Medium Body) — Pack of 10	972-1002
Elements Gutta Percha Cartridge 25GA (Light Body) — Pack of 10	972-1003
Elements Gutta Percha Cartridge 23GA (Heavy Body) — Pack of 10	972-1005

Buchanan Hand Plugger

These high-quality pluggers are shaped to closely match the final root canal preparation. This maximises condensation forces on the softened obturation material without placing undue stress on the root canal system.

Featuring both a tapered NiTi end and a stainless steel end, Buchanan hand pluggers can be used in all common obturation techniques, including warm and cold condensation. The pluggers are also ideal for back-filling canals. The colour-coded NiTi end can be used for finishing condensation procedures, even in the most radically curved canals. Both ends condense and control the gutta-percha.

Buchanan Hand Plugger	REF/Part No.
Buchanan Hand Plugger 0	974-0060
Buchanan Hand Plugger 1	974-0058
Buchanan Hand Plugger 2	974-0059



Buchanan Hand Plugger 0



Buchanan Hand Plugger 1



Buchanan Hand Plugger 2

Autofit Paper Points

Developed by Dr. L. Stephen Buchanan, the Autofit Paper Points are an integral part of the Autofit system. The tapers of various sizes are colour-coded for easy identification and will fit perfectly into greater taper preparations.



Autofit Paper Points

Standard Sizes	REF/Part No.
No. 15 – Pack of 200	13971
No. 20 – Pack of 200	13972
No. 25 – Pack of 200	13973
No. 30 – Pack of 200	13974
No. 35 – Pack of 200	13975
No. 40 – Pack of 200	13976

Standard Sizes	REF/Part No.
No. 45 – Pack of 200	13977
No. 50 – Pack of 200	13978
No. 55 – Pack of 200	13979
No. 60 – Pack of 200	13980
No. 70 – Pack of 200	13981
No. 80 – Pack of 200	13982

Non-Standard Sizes	REF/Part No.
Xtra-fine – XF – Pack of 200	13966
Fine – F – Pack of 200	13967
Medium – M – Pack of 200	13968
Course – C – Pack of 200	13969
Xtra-course – XC – Pack of 200	13970
Assorted – XF, F, M, C – Pack of 200	13965

Soft-Core™

Carrier-based Soft-Core™ obturators are 30% thinner, allowing greater flexibility to navigate curved canals. A thinner core also means more gutta-percha for denser fills every time. With just one universal taper size, the Soft-Core simplifies carrier inventory.

The Soft-Core™ is made from alpha phase gutta-percha and offers exceptional flow properties, adhesion and improved sealing.



Soft-Core™ Oven

Soft-Core™ Classic Obturator Econo Intro Kit

REF/Part No. 972-3000

1x Soft-Core oven, 3x Soft-Core™ Obturation packs (6 pcs). No. 20, No. 25, No. 30 and No. 35, 2x Soft-Core™ Verifier packs (6 pcs). No. 20, No. 25, No. 30 and No. 35, 1x LA Axxess stainless steel drill (6 pcs).

Soft-Core™ Oven

REF/Part No. 972-3002

The Soft-Core oven provides a simple and consistent method for the simultaneous heating of up to 4 Soft-Core obturators.

Soft-Core™ Obturator — Pack of 6

REF/Part No.

Soft-Core Obturator — No. 20	972-3020
Soft-Core Obturator — No. 25	972-3025
Soft-Core Obturator — No. 30	972-3030
Soft-Core Obturator — No. 35	972-3035
Soft-Core Obturator — No. 40	972-3040
Soft-Core Obturator — No. 45	972-3045
Soft-Core Obturator — No. 50	972-3050
Soft-Core Obturator — No. 55	972-3055
Soft-Core Obturator — No. 60	972-3060

Soft-Core™ Obturator — Economy Pack of 36

REF/Part No.

Soft-Core Obturator — No. 20	972-3120
Soft-Core Obturator — No. 25	972-3125
Soft-Core Obturator — No. 30	972-3130
Soft-Core Obturator — No. 35	972-3135
Soft-Core Obturator — No. 40	972-3140
Soft-Core Obturator — No. 45	972-3145
Soft-Core Obturator — No. 50	972-3150
Soft-Core Obturator — No. 55	972-3155
Soft-Core Obturator — No. 60	972-3160

Soft-Core™ Verifier — Pack of 6

REF/Part No.

Soft-Core Verifier — No. 20	972-3220
Soft-Core Verifier — No. 25	972-3225
Soft-Core Verifier — No. 30	972-3230
Soft-Core Verifier — No. 35	972-3235
Soft-Core Verifier — No. 40	972-3240
Soft-Core Verifier — No. 45	972-3245
Soft-Core Verifier — No. 50	972-3250
Soft-Core Verifier — No. 55	972-3255
Soft-Core Verifier — No. 60	972-3260

K3™ Gutta-Percha

Made specifically for use with K3 files.

K3 Gutta-Percha — Pack of 50

Taper	Tip	REF/Part No.
.06	45	825-0645
.06	40	825-0640
.06	35	825-0635
.06	30	825-0630
.06	25	825-0625
.06	20	825-0620
.06	20-40	825-0600
.06	Feather Tip	825-0048

K3 Gutta-Percha — Pack of 50

Taper	Tip	REF/Part No.
.04	45	825-0445
.04	40	825-0440
.04	35	825-0435
.04	30	825-0430
.04	25	825-0425
.04	20	825-0420
.04	20-40	825-0400
.04	Feather Tip	825-0047



K3 Gutta-Percha

Autofit Gutta-Percha

Made specifically for use with the Autofit system.

Autofit Gutta-Percha — Pack of 50

Taper	REF/Part No.
.04	972-0101
.06	972-0102
.08	972-0103
.10	972-0104
.12	972-0105
.12	972-0107
Assorted .06 — .12	972-0100

Autofit Gutta-Percha — Pack of 100

Size	REF/Part No.
Fine - Fine	952-0010
Medium - Fine	952-0011
Fine	952-0012
Fine - Medium	952-0013
Medium	952-0014
Medium - Large	952-0015
NON-STD L	952-0016

Autofit Backfill Gutta-Percha — Pack of 60

Size	REF/Part No.
Fine	972-0020
Fine - Medium	972-0021
Medium	972-0022
Medium - Large	972-0023

TF Gutta-Percha points

For use with the TF rotating NiTi files.

TF Gutta-Percha points — Pack of 50

Taper	Tip	REF/Part No.
.12	25	822-1225
.10	25	822-1025
.08	25	822-0825
.06	25	822-0625
.04	25	822-0425
.04-.12	25	822-0010
.04-.06	25-50	822-0020

TF Apical Gutta-Percha points — Pack of 50

Taper	Tip	REF/Part No.
.06	30	822-0630
.06	35	822-0635
.04	40	822-0440
.04	50	822-0450

Sealapex™

Sealapex™ is the original eugenol-free root canal sealant based on calcium hydroxide, which promotes rapid healing and the formation of hard tissue.

Sealapex™

REF/Part No. 18432

1x Sealapex Base, 1x Sealapex Accelerator, 1x Mixing Pad

Sealapex™ — Bulk Pack

REF/Part No. 18598

24x Sealapex Base, 24x Sealapex Accelerator, 6x Mixing Pad

Sealapex™ Xpress

REF/Part No. 33639

2x 10.5g Dual Delivery Syringe, 10x Mixing Tips



Sealapex™ Xpress

Tubli-Seal™

Tubli-Seal™ is a paste/paste zinc oxide eugenol root canal sealant. It is light in colour, non-darkening and radiopaque.

Tubli-Seal™ EWT offers all the benefits of Tubli-Seal but with a longer processing time.

Tubli-Seal™

REF/Part No. 00340

1x Tubli-Seal Base, 1x Tubli-Seal Accelerator, 1x Mixing Pad

Tubli-Seal™ EWT

REF/Part No. 25903

1x Tubli-Seal EWT Base, 1x Tubli-Seal EWT Accelerator, 1x Mixing Pad

Tubli-Seal™ Xpress

REF/Part No. 33640

2x 10.5g Dual Delivery Syringe, 10x Mixing Tips

Tubli-Seal™ EWT Xpress

REF/Part No. 33641

2x 10.5g Dual Delivery Syringe, 10x Mixing Tips



Tubli-Seal™



Tubli-Seal™ EWT Xpress

Pulp Canal Sealer™

Pulp Canal Sealer™ is a zinc oxide eugenol sealant with a powder base and liquid catalyst. The formula is non-irritating and radiopaque.

Pulp Canal Sealer EWT offers a processing time in excess of 6 hours.

Pulp Canal Sealer™ — Standard Pack REF/Part No. 24875

1x Pulp Canal Sealer Liquid, 1x Pulp Canal Sealer Powder, 2x Mixing Spoon

Pulp Canal Sealer™ EWT — Standard Pack REF/Part No. 24746

24x Sealapex Base, 24x Sealapex Accelerator, 6x Mixing Pad

Pulp Canal Sealer™ — Refills REF/Part No.

Pulp Canal Sealer Bulk Liquid Refill — 4 pcs	24873
Pulp Canal Sealer Bulk Powder Refill — 4 pcs	24745
Pulp Canal Sealer EWT Bulk Powder Refill — 4 pcs	24874



Pulp Canal Sealer™



Pulp Canal Sealer™ EWT

Simplify your day.

The Kerr Restoratives range originates from a strong resolve to provide solutions that can complement the skills of the practitioner throughout a restorative treatment.

The range leverages a history of clinical success to create reliable outcomes and industry-defining innovations through unique solutions, such as:

- The next generation aesthetic composite with outstanding handling and light reflection properties, Harmonize™
- The first permanent cement with a colour clean-up indicator, Maxcem Elite™ Chroma
- The universal bonding agent derived from decades of gold standard adhesion, OptiBond™ eXTRa Universal

Choosing Kerr Restoratives means relying on a complete suite of direct, indirect and laboratory products, from impression to final polish, that are designed to work together, and create a safe and comfortable experience for the user and the patient.



A focus on aesthetics



Aesthetic results are not limited to cosmetic dentistry. Any patient leaving the dental office expects to feel good about their final appearance.

And while individual products can help improve outcomes, truly aesthetic success stems from a coordinated action by each product used in a procedure, from the smallest matrix to the most powerful curing light.





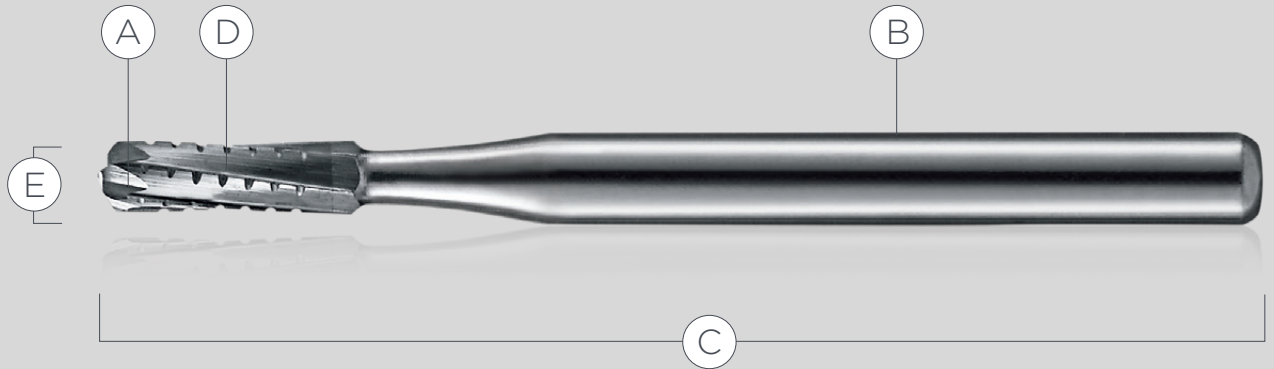

For each step, Kerr Restoratives offers some of the leading products available on the market. These solutions work together in harmony and can make any restoration simpler and more predictable, as well as beautiful to look at.

3.1 Burs — Jet carbides



- A** — Material of cutting surface — carbide
- B** — Shank and overall length (HP, LA, FG, etc.)
- C** — Shank and overall length (HP, LA, FG, etc.)
- D** — Shape and type of finish (Round, Cylinder, Kriss Kross, etc.)
- E** — Nominal size (ISO 2157), largest cutting head diameter in 1/10 mm

Shank type

Code	Shank Type	Image	Diameter (mm)	Length (mm)	ISO
FG SS	Friction Grip Short Shank		1.6	16.5	313
FG	Friction Grip		1.6	19	314
FG OS	Friction Grip Oral Surgical		1.6	25	316
LA	Latch		2.35	22	204
LA OS	Latch Oral Surgical		2.35	26	205
HP	Handpiece		2.35	44.5	104
HP OS	Handpiece Oral Surgical		2.35	65	105

Operative Carbides

Kerr burs are available in a range of head shapes and with patient safety and dentist comfort in mind; all operative carbides are designed to prevent slippage of the tool during even the most delicate cavity preparation procedures.



Round

Ideal for initial entry, excavating infected dentine, extending preparation walls, creating retentive features and endodontic access. Smaller head diameters help create ultra-conservative preparations.

US Shape #	1/4	1/2	1	2	3	4	5	6	7	8	10
Diameter	005	006	008	010	012	014	016	018	021	023	027
Friction Grip (FG)											
REF/Part No. Pcs 5	400002-JK5	400001-JK5	400003-JK5	400050-JK5	400070-JK5	400086-JK5	400087-JK5	400104-JK5	400108-JK5	400154-JK5	
REF/Part No. Pcs 100			400003-JTC	400050-JTC	400070-JTC	400086-JTC	400087-JTC	400104-JTC	400108-JTC	400154-JTC	
Short Shank (FG SS)											
REF/Part No. Pcs 5		400205-JK5		400220-JK5							
REF/Part No. Pcs 100				400220-JTC		400234-JTC					
Latch (LA)											
REF/Part No. Pcs 5		400326-JK5	400328-JK5	400339-JK5	400341-JK5	400353-JK5	400354-JK5	400363-JK5		400375-JK5	
REF/Part No. Pcs 100			400328-JTC	400339-JTC	400341-JTC	400353-JTC	400354-JTC	400363-JTC		400375-JTC	
Oral Surgical (FGOS)											
REF/Part No. Pcs 5						400189-JK5					
REF/Part No. Pcs 100				400185-JTC	400187-JTC	400189-JTC		400198-JTC		400204-JTC	
Handpiece (HP)											
REF/Part No. Pcs 5	400253-JK5	400252-JK5	400254-JK5			400284-JK5		400296-JK5			400255-JK5
REF/Part No. Pcs 100	400253-JTC	400252-JTC	400254-JTC	400276-JTC		400284-JTC		400296-JTC		400313-JTC	400255-JTC



Pear

Creates a preparation with converging walls and round internal line angles. Ideal for creating mechanical retention and maintaining full-length enamel rod margins on pit and fissure surfaces.

US Shape #	329	330	331	331L	332	332L	333L
Head Length	1.6	1.6	1.6	4.1	1.6	4.1	4.1
Diameter	005	006	008	010	012	012	014
Friction Grip (FG)							
REF/Part No. Pcs 5	400071-JK5	400073-JK5	400074-JK5	400075-JK5	400076-JK5	400077-JK5	400078-JK5
REF/Part No. Pcs 100		400073-JTC	400074-JTC		400076-JTC		
Short Shank (FG SS)							
REF/Part No. Pcs 5			400226-JK5		400228-JK5		
Latch (LA)							
REF/Part No. Pcs 5		400343-JK5					
REF/Part No. Pcs 100		400343-JTC					



Amalgam Prep

FG 245 offers a longer head length and flat floors with rounded internal line angles for amalgam preparations.

US Shape #	245
Head Length	2.7
Diameter	009
Friction Grip (FG)	
REF/Part No. Pcs 5	400062-JK5
Short Shank (FG SS)	
REF/Part No. Pcs 5	400221-JK5



Inverted Cone

Offers a sharp taper ideal for creating mechanical locks in preparations.



US Shape #	33 1/2	34	35	36	37	38	39
Head Length	0.4	0.6	0.7	0.8	0.8	1	1.3
Diameter	006	008	010	012	014	016	018

Friction Grip (FG)

REF/Part No. Pcs 5	400072-JK5	400079-JK5	400080-JK5	400081-JK5	400082-JK5		400085-JK5
REF/Part No. Pcs 100		400079-JTC	400080-JTC				

Short Shank (FG SS)

REF/Part No. Pcs 5		400230-JK5	400231-JK5		400233-JK5		
--------------------	--	------------	------------	--	------------	--	--

Latch (LA)

REF/Part No. Pcs 5		400347-JK5		400349-JK5			
REF/Part No. Pcs 100					400350-JTC	400351-JTC	

Handpiece (HP)

REF/Part No. Pcs 5				400281-JTC			400283-JTC
--------------------	--	--	--	------------	--	--	------------



Straight Flat-End Fissure

Creates a preparation with parallel walls and a flat floor. Useful for establishing the periphery of a preparation.



US Shape #	56	57	57L	58
Head Length	3.2	3.7	4.9	3.7
Diameter	009	010	010	012

Friction Grip (FG)

REF/Part No. Pcs 5	400096-JK5	400099-JK5	400100-JK5	400101-JK5
REF/Part No. Pcs 100	400096-JTC	400099-JTC		

Short Shank (FG SS)

REF/Part No. Pcs 5	400241-JK5	400242-JK5		
--------------------	------------	------------	--	--

Latch (LA)

REF/Part No. Pcs 5		400360-JK5		
REF/Part No. Pcs 100				400361-JTC



Straight Flat-End X-Cut Fissure

Cross-Cuts increase cutting efficiency and facilitate cutting dentine at lower speeds for improved tactile response.

US Shape #	257	556	557	557L	558	558L	559	560
Head Length	3.7	3.2	3.7	4.9	3.7	4.9	4.1	4.1
Diameter	010	009	010	010	012	012	014	016
Friction Grip (FG)								
REF/Part No. Pcs 5	400065-JK5	400089-JK5	400091-JK5	400092-JK5	400093-JK5	400094-JK5	400095-JK5	400097-JK5
REF/Part No. Pcs 100		400089-JTC	400091-JTC		400093-JTC			
Short Shank (FG SS)								
REF/Part No. Pcs 5		400236-JK5						
REF/Part No. Pcs 100			400237-JTC		400239-JTC			
Latch (LA)								
REF/Part No. Pcs 5			400356-JK5		400357-JK5			
Handpiece (HP)								
REF/Part No. Pcs 5								400292-JK5
REF/Part No. Pcs 100							400290-JTC	400292-JTC



Straight Round End Fissure

Dome Ends create rounded internal line angles to distribute occlusal forces.

US Shape #	1156	1157	1158
Head Length	3.2	3.7	3.7
Diameter	009	010	012
Friction Grip (FG)			
REF/Part No. Pcs 5	400006-JK5	400007-JK5	400008-JK5
REF/Part No. Pcs 100		400007-JTC	400008-JTC



Straight Round End X-Cut Fissure

Dome Ends create rounded internal line angles to distribute occlusal forces. Cross-Cuts increase cutting efficiency and facilitate cutting dentine at lower speeds for improved tactile response.

US Shape #	1556	1557	1558
Head Length	3.2	3.7	3.7
Diameter	009	010	012
Friction Grip (FG)			
REF/Part No. Pcs 5	400017-JK5	400018-JK5	400020-JK5
REF/Part No. Pcs 100	400017-JTC	400018-JTC	400020-JTC
Handpiece (HP)			
REF/Part No. Pcs 5			400265-JK5
REF/Part No. Pcs 100		400264-JTC	



Taper Flat-End Fissure

Creates diverging preparation walls ideal for indirect restorations. Cross-Cuts increase cutting efficiency. Dome Ends create rounded internal line angles to distribute occlusal forces better. Tapered shape helps maintain full-length enamel rod margins on convex tooth surfaces.

US Shape #	168	169	169L	170	170L	171	171L
Head Length	3.2	3.2	4.9	3.7	4.9	3.7	4.9
Diameter	008	009	009	010	010	012	012

Friction Grip (FG)

REF/Part No. Pcs 5	400022-JK5	400023-JK5	400025-JK5	400026-JK5	400031-JK5	400032-JK5	400033-JK5
REF/Part No. Pcs 100				400026-JTC	400031-JTC		



Taper Flat-End X-Cut Fissure

The tapered shape helps maintain full-length enamel rod margins on convex tooth surfaces. Creates diverging preparation walls ideal for indirect restorations. Cross-Cuts increase cutting efficiency.

US Shape #	699	699L	700	700L	701	701L	702	703
Head Length	3.2	4.9	3.7	4.9	3.7	4.9	4.1	4.5
Diameter	009	009	010	010	012	012	016	021

Friction Grip (FG)

REF/Part No. Pcs 5	400106-JK5	400107-JK5	400109-JK5	400116-JK5	400117-JK5	400118-JK5	400119-JK5	400120-JK5
REF/Part No. Pcs 100	400106-JTC			400116-JTC			400119-JTC	

Short Shank (FG SS)

REF/Part No. Pcs 5	400245-JK5							
--------------------	------------	--	--	--	--	--	--	--

Latch (LA)

REF/Part No. Pcs 100			400367-JTC					
----------------------	--	--	------------	--	--	--	--	--

Handpiece (HP)

REF/Part No. Pcs 5	400298-JK5		400301-JK5			400305-JK5		
REF/Part No. Pcs 100	400298-JTC	400299-JTC		400303-JTC			400306-JTC	400308-JTC



Taper Round End Fissure

The tapered shape helps maintain full-length enamel rod margins on convex tooth surfaces.

US Shape #	1169L	1170	1170L	1171	1171L	1172
Head Length	4.9	3.7	4.9	3.7	4.9	4.1
Diameter	009	010	010	012	012	016
Friction Grip (FG)						
REF/Part No. Pcs 5	400010-JK5		400012-JK5	400013-JK5	400014-JK5	400015-JK5
REF/Part No. Pcs 100	400010-JTC		400012-JTC	400013-JTC	400014-JTC	400015-JTC
Latch (LA)						
REF/Part No. Pcs 5				400332-JK5		400333-JK5
REF/Part No. Pcs 100				400332-JTC		400333-JTC
Handpiece (HP)						
REF/Part No. Pcs 100		400259-JTC		400261-JTC		400262-JTC



Taper Round End X-Cut Fissure

Cross-Cuts increase cutting efficiency.

US Shape #	1701
Head Length	3.7
Diameter	012
Friction Grip (FG)	
REF/Part No. Pcs 5	400029-JK5
REF/Part No. Pcs 100	400029-JTC

Trimming and finishing carbides

Trimming and Finishing Carbides are offered in a wide variety of shapes and sizes, which are essential for achieving optimal aesthetic results. The single piece construction and sharp, precision-ground finishing carbide flutes promote a smooth, vibration-free and comfortable experience.



Egg

For contouring or placing anatomy on posterior occlusal surfaces. Also suitable for smoothing and shaping anterior lingual surfaces. Available in 12 and 30 blade-count configurations.

US Shape #	7404	7406	7408	9406
Head Length	2.8	3.4	3.6	3.4
Diameter	014	018	023	018
Blades	12	12	12	30
Friction Grip (FG)				
REF/Part No. Pcs 5	400134-JK5	400135-JK5	400136-JK5	400161-JK5
REF/Part No. Pcs 100	400134-JTC	400135-JTC	400136-JTC	
Latch (LA)				
REF/Part No. Pcs 100		400373-JTC		



Bullet

Ideal for initial definition of fissures and anatomy in posterior teeth. Available in 12 and 30 blade-count configurations.

US Shape #	7801	7802	7803	9803
Head Length	2.7	2.8	2.9	2.9
Diameter	014	018	023	012
Blades	12	12	12	30
Friction Grip (FG)				
REF/Part No. Pcs 5	400148-JK5	400149-JK5	400150-JK5	400171-JK5
REF/Part No. Pcs 100	400148-JTC	400149-JTC	400150-JTC	400171-JTC



Round

Ideal for finishing anterior lingual and posterior occlusal surfaces.
Available in 12 and 30 blade-count cutting heads.

US Shape #	7002	7004	7006	7008	7009	9004	9006	9008
Head Length	-	-	-	-	-	-	-	-
Diameter	010	014	018	023	025	014	018	023
Blades	12	12	12	12	12	30	30	30
Friction Grip (FG)								
REF/Part No. Pcs 5		400112-JK5	400113-JK5	400114-JK5	400115-JK5	400156-JK5	400157-JK5	400158-JK5
REF/Part No. Pcs 100	400110-JTC	400112-JTC				400156-JTC		400158-JTC
Latch (LA)								
REF/Part No. Pcs 5			400368-JK5					



Needle

Establishes anatomical pits and fissures in occlusal surfaces.
Available in 12 and 30 blade-count configurations.

US Shape #	7901	7902	7903	9903	9904
Head Length	2.2	3.4	3.4	4.9	4.9
Diameter	009	010	012	012	014
Blades	12	12	12	30	30
Friction Grip (FG)					
REF/Part No. Pcs 5	400151-JK5	400152-JK5	400153-JK5	400172-JK5	400173-JK5
REF/Part No. Pcs 100	400151-JTC	400152-JTC	400153-JTC		
Latch (LA)					
REF/Part No. Pcs 100		400373-JTC			



Flame

Useful in establishing and defining pit and fissure anatomy. Available in 12 blade-count configuration.

US Shape #	7801	7802	9803
Head Length	2.7	2.8	2.9
Diameter	014	018	012
Blades	12	12	30
Friction Grip (FG)			
REF/Part No. Pcs 5	400148-JK5	400149-JK5	400171-JK5
REF/Part No. Pcs 100			



Taper Finishing

Ideal for trimming excess material on anterior labial surfaces or the cervical portion of any tooth. Available in Needle Point, Round End and Flat-End shapes in multiple lengths to match any contouring challenge.

US Shape #	7114	7214	7714	9214	9714
Head Length	2.9	5.1	7.6	5.1	7.6
Diameter	009	010	014	010	014
Blades	6	6	6	12	12
Friction Grip (FG)					
REF/Part No. Pcs 5	400125-JK5	400129-JK5	400147-JK5	400160-JK5	400169-JK5
REF/Part No. Pcs 100	400125-JTC	400129-JTC	400147-JTC		400169-JTC

US Shape #	7204	7702	7713	7642	7664	7283	9713	9642
Head Length	8.5	4.9	4.9	5.7	8.6	9.9	5.1	5.7
Diameter	014	010	012	010	015	016	012	010
Blades	18	18	18	18	18	18	30	30
Friction Grip (FG)								
REF/Part No. Pcs 5	400126-JK5	400145-JK5		400143-JK5	400144-JK5	400130-JK5	400168-JK5	
REF/Part No. Pcs 100			400146-JTC		400144-JTC			400167-JTC



Concave Interproximal

Ideal for removing excess composite from proximal margins and embrasures. Available in 12 blade-count configuration.

US Shape #	7103
Head Length	3.7
Diameter	012
Blades	12
Friction Grip (FG)	
REF/Part No. Pcs 5	400121-JK5

Speciality carbides

Speciality carbides are a critical component to the dental practice's laboratory work. Our range of speciality carbides encompass the professional needs of dental practices and are designed to help get it right first time, from trim and finish work to crowns and bridges.

Fine Cross-Cut

Fine Cross-Cut burs feature traditional head shapes with maximum density cross-cuts in the bur blades to dramatically increase cutting efficiency while simultaneously decreasing undesirable chatter, friction and clogging. Perfect for rapid reduction or crown removal. The slightly roughened preparation surface is ideal for improving micromechanical retention in composite preparations. Fine Cross-Cut burs are available in a wide variety of shapes to meet every clinical situation.



Pear

US Shape #	1930	1931	1932
Head Length	1.6	1.6	1.6
Diameter	008	010	012
Friction Grip (FG)			
REF/Part No. Pcs 5	400037-JK5	400038-JK5	400039-JK5
REF/Part No. Pcs 100		400038-JTC	



Amalgam Prep

US Shape #	1945	1946
Head Length	2.7	3.7
Diameter	009	012
Friction Grip (FG)		
REF/Part No. Pcs 5	400040-JK5	400041-JK5
REF/Part No. Pcs 100		400041-JTC



Straight Fissure

US Shape #	2057	2058
Head Length	3.7	3.7
Diameter	010	012

Friction Grip (FG)

REF/Part No. Pcs 5	400052-JK5	400053-JK5
--------------------	------------	------------

Short Shank (FG SS)

REF/Part No. Pcs 5	400520-JK5
--------------------	------------



Straight Fissure Dome

US Shape #	1956	1957	1958	1958L
Head Length	3.2	3.7	3.7	4.9
Diameter	009	010	012	012

Friction Grip (FG)

REF/Part No. Pcs 5	400042-JK5	400043-JK5	400044-JK5	400045-JK5
--------------------	------------	------------	------------	------------

REF/Part No. Pcs 100

			400044-JTC	
--	--	--	------------	--



Taper Dome End

US Shape #	1970	1971
Head Length	3.7	3.7
Diameter	010	012

Friction Grip (FG)

REF/Part No. Pcs 5	400047-JK5	400048-JK5
--------------------	------------	------------



Taper Flat-End

US Shape #	2070	2071	2072
Head Length	3.7	3.7	4.1
Diameter	010	012	016

Friction Grip (FG)

REF/Part No. Pcs 5	400055-JK5	400056-JK5	400532-JK5
--------------------	------------	------------	------------

REF/Part No. Pcs 100		400056-JTC	400532-JTC
----------------------	--	------------	------------

Kriss Kross

The unique pyramid-shaped geometry facilitates cutting through tough materials like amalgam and porcelain with ease. Available in Straight Fissure and Taper shapes.



Straight Dome



Taper Dome

US Shape #	2157	2158
Head Length	3.7	3.7
Diameter	010	012
Friction Grip (FG)		
REF/Part No. Pcs 5	400057-JK5	400058-JK5
REF/Part No. Pcs 100	400057-JTC	400058-JTC

US Shape #	2170	2171
Head Length	3.7	3.7
Diameter	012	012
Friction Grip (FG)		
REF/Part No. Pcs 5	400059-JK5	400060-JK5
REF/Part No. Pcs 100	400059-JTC	400060-JTC

Solid Carbide

The single-piece construction of our Solid Carbide burs improves strength and reliability. Simultaneously increases corrosion resistance.



US Shape #	170	245	330	557	1557	199Z
Head Length	3.7	2.7	1.6	3.7	3.7	10.0
Diameter	010	009	008	010	010	015
Friction Grip (FG)						
REF/Part No. Pcs 5	400026-JK5	400062-JK5	400073-JK5	400091-JK5	400018-JK5	440007-JK5
REF/Part No. Pcs 100			400073-JTC	400091-JTC	400018-JTC	440007-JTC
Short Shank (FG SS)						
REF/Part No. Pcs 5		400221-JK5	400225-JK5			
REF/Part No. Pcs 100			400225-JTC	400237-JTC		
Latch (LA)						
REF/Part No. Pcs 5			400343-JK5	400356-JK5	400334-JK5	
REF/Part No. Pcs 100				400356-JTC		
Handpiece (HP)						
REF/Part No. Pcs 5				400288-JK5		
REF/Part No. Pcs 100				400288-JTC		

3.1 Burs — Jet diamonds

Kerr Jet Diamonds are available in packs of 5 or Gold Packs of 50.

Uniform particle dispersion.

Exceptional cutting efficiency and durability for less chair time and better value

Consistent diamond particle size.

No chattering or vibrating of the handpiece, reduces heat, smooth cutting

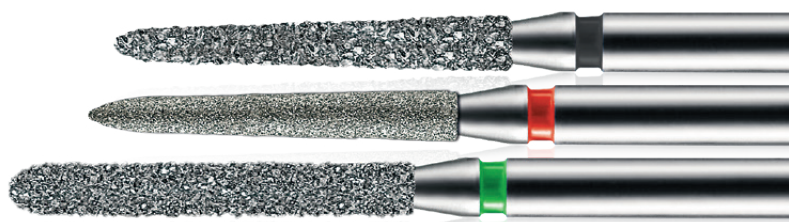

Define to Finish Series

MFG REF.	132	133	134	135	274	379	247	32855	368	368	368
Head Length	3.0	4.0	6.0	9.0	3.5	4.5	3.2	6.0	3.5	4.5	5.0
Diameter	008	010	014	014	016	023	009	014	016	018	023
Super-coarse								SC32855-014			SC368-023
Coarse										C368-018	C368-023
Medium										M368-018	M368-023
Fine	F132-008	F133-010	F134-014	F135-014	F274-016	F379-023	F247-009		F368-016	F368-018	F368-023
Super-fine	SF132-008	SF133-010	SF134-014	SF135-014	SF274-016	SF379-023	SF247-009		SF368-016	SF368-018	SF368-023
Ultra-fine											

MFG REF.	369	379	379	379	379	392	801	801	801	801	801
Head Length	5.5	3.0	3.4	3.5	4.5	5.0	1.0	1.2	1.4	1.6	1.8
Diameter	025	014	016	018	023	016	010	012	014	016	018
Super-coarse				SC379-018	SC379-023					SC801-016	SC801-018
Coarse	C369-025			C379-018	C379-023			C801-012	C801-014	C801-016	C801-018
Medium					M379-023	M392-016	M801-010	M801-012	M801-014	M801-016	M801-018
Fine		F379-014	F379-016	F379-018	F379-023	F392-016					
Super-fine			SF379-016	SF379-018	SF379-023	SF392-016					
Ultra-fine					UF379-023						



MFG REF.	801	801	801	801	807	807	811	811	811	813	830
Head Length	2.1	2.3	2.5	2.9	4.0	5.0	4.2	7.0	7.0	1.6	2.7
Diameter	021	023	025	029	016	018	033	037	047	014	010
Super-coarse	SC801-021	SC801-023	SC801-025	SC801-029			SC811-033	SC811-037	SC811-047		
Coarse	C801-021	C801-023	C801-025	C801-029	C807-016	C807-018	C811-033	C811-037	C811-047	C813-014	C830-010
Medium		M801-023									M830-010
Fine		F801-023									
Super-fine		SF801-023									
Ultra-fine											

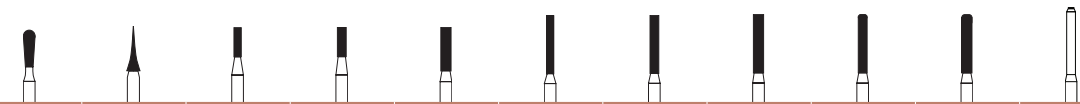

MFG REF.	830L	833	835	835	836	837	837	837	837KR	837KR	840
Head Length	5.0	5.9	4.0	4.0	6.0	8.0	8.0	8.0	8.0	8.0	1.0
Diameter	016	018	010	012	014	010	012	014	012	014	012
Super-coarse	SC830L-016		SC835-010		SC836-014		SC837-012	SC837-014	SC837KR-012	SC837KR-014	
Coarse	C830L-016		C835-010	C835-012	C836-014	C837-010	C837-012	C837-014	C837KR-012	C837KR-014	
Medium			M835-010								M840-012
Fine		F833-018									
Super-fine		SF833-018									
Ultra-fine											



MFG REF.	840	845KR	845KR	845KR	846	846KR	847	847	847	847	847KR
Head Length	1.1	4	4	4	6	6	8.0	8.0	8.0	8.0	8.0
Diameter	014	016	018	025	016	016	012	014	016	018	016
Super-coarse		SC845KR-016				SC846KR-016	SC847-012	SC847-014	SC847-016	SC847-018	SC847KR-016
Coarse		C845KR-016	C845KR-018	C845KR-025	C846-016	C846KR-016	C847-012	C847-014	C847-016	C847-018	C847KR-016
Medium	M840-014	M845KR-016	M845KR-018	M845KR-025		M846KR-016					
Fine									F847-016		F847KR-016
Super-fine											
Ultra-fine											

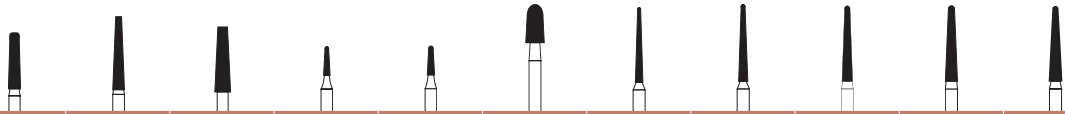

MFG REF.	847KR	848	848	849	849	849	850	850	850	850	850
Head Length	8	10	10	4	4	4	10.0	10.0	10.0	10.0	10.0
Diameter	018	016	023	009	010	025	010	012	014	016	018
Super-coarse	SC847KR-018	SC848-016	SC848-023			SC849-025			SC850-014	SC850-016	SC850-018
Coarse	C847KR-018	C848-016	C848-023			C849-025	C850-010	C850-012	C850-014	C850-016	C850-018
Medium		M848-016		M849-009				M850-012	M850-014	M850-016	M850-018
Fine					F849-010			F850-012			
Super-fine					SF849-010						
Ultra-fine											



MFG REF.	852	852	855	855	855	856	856	856	856	856	856
Head Length	4.0	6.0	6.0	6.0	7.0	8.0	8.0	8.0	8.0	8.0	8.0
Diameter	010	012	012	014	025	012	014	016	018	021	025
Super-coarse			SC855-012	SC855-014	SC855-025	SC856-012	SC856-014	SC856-016*	SC856-018	SC856-021	SC856-025
Coarse		C852-012	C855-012	C855-014	C855-025	C856-012	C856-014	C856-016**	C856-018	C856-021	C856-025
Medium						M856-012	M856-014	M856-016	M856-018***		
Fine	F852-010	F852-012					F856-014	F856-016	F856-018		
Super-fine	SF852-010	SF852-012									
Ultra-fine		UF852-012									

* Mini and/or Gold Pack
 ** Mini/Short Shank
 *** Gold Pack (50 per pack)



MFG REF.	856L	856L	856L	856L	858	858	858	859	859	859	859L
Head Length	9.0	9.0	9.0	9.0	8.0	8.0	8.0	10.0	10.0	10.0	10.0
Diameter	014	016	018	020	010	012	014	010	012	014	014
Super-coarse	SC856L-014	SC856L-016	SC856L-018				SC858-014				
Coarse	C856L-014	C856L-016	C856L-018	C856L-020			C858-014		C859-012	C859-014	
Medium		M856L-016						M859-010		M859-014	
Fine		F856L-016			F858-010	F858-012	F858-014	F859-010	F859-012	F859-014	F859-014
Super-fine							SF858-014	SF859-010	SF859-012	SF859-014	
Ultra-fine											



MFG REF.	859	859	862	862	862	862	863	863	863	863	877K
Head Length	10.0	10.0	8.0	8.0	8.0	8.0	10.0	10.0	10.0	10.0	6.0
Diameter	016	018	010	012	014	016	010	012	014	016	014
Super-coarse				SC862-012	SC862-014	SC862-016		SC863-012	SC863-014	SC863-016	SC877K-014
Coarse			C862-010	C862-012	C862-014	C862-016		C863-012	C863-014	C863-016	C877K-014
Medium			M862-010	M862-012				M863-012			
Fine	F859-016	F859-018	F862-010	F862-012			F863-010	F863-012			
Super-fine	SF859-016		SF862-010	SF862-012			M863-010	SF863-012			
Ultra-fine			C862010M					UF863-012			



MFG REF.	877K	877K	878	878K	878K	878K	878K	885	885	888	889
Head Length	6.0	6.0	8.0	8.0	8.0	8.0	8.0	8.0	8.0	8.0	3.5
Diameter	016	018	012	012	014	016	018	012	014	012	009
Super-coarse	SC877K-016	SC877K-018	SC878-012	SC878K-012	SC878K-014	SC878K-016	SC878K-018	SC885-012	SC885-014		
Coarse	C877K-016	C877K-018	C878-012	C878K-012	C878K-014	C878K-016	C878K-018	C885-012	C885-014	C888-012	
Medium						M878K-016					
Fine										F888-012	F889-009
Super-fine										SF888-012	SF889-009
Ultra-fine											

Speciality Diamonds



MFG REF.	889	909	909	MADC	KSO	KS1	KS2	KS3	KS4	KS5	KS6
Head Length	3.5	1.0	2.0	2.0	7.0	7.0	8.0	8.0	4.2	6.2	
Diameter	010	037	040	020	010	012	014	016	023	031	
Super-coarse		SC909-037	C909-040			KS1	KS2	KS3	KS4	KS5	
Coarse		C909-037	SC 909-040								
Medium				MADC-020	KSO						KS6
Fine	F889-010										
Super-fine	SF889-010										
Ultra-fine											

3.1 Burs — BluWhite diamonds



BluWhite diamonds are a great option for any procedure. The unique diamond application process ensures excellent diamond particle retention and cutting surface throughout multiple-uses. Their outstanding cutting efficiency reduces chatter and instrument wear and tear.



Grit type

Grit	Colour Band	Microns
Super-fine	● Yellow	44 – 62
Fine	● Red	74 – 88
Regular (Medium)	● Blue	105 – 125
Coarse	● Green	125 – 149
Extra-coarse	● Black	177 – 250

Shank type

Code	Shank Type	Image	Package
FG SS	Friction Grip Short Shank		1 per pack
FG	Friction Grip		1 per pack

Amalgam Remover



	1.3	6.0
Head Length		
Diameter	014	018
● Super-fine		
● Fine		
● Regular	450192-BD1	450194-BD1
● Coarse		
● Extra-coarse		

Equilibrating & Contouring



	2.8
Head Length	
Diameter	018
● Super-fine	
● Fine	450285-BD1
● Regular	450286-BD1
● Coarse	450284-BD1
● Extra-coarse	

Curettage



	5.8	7.8	9.8	5.8	9.8	7.8	9.8
Head Length	5.8	7.8	9.8	5.8	9.8	7.8	9.8
Diameter	014	014	014	016	016	018	018
● Super-fine							
● Fine		450004-BD1	450007-BD1	450010-BD1	450016-BD1	450022-BD1	
● Regular	450002-BD1	450005-BD1	450008-BD1		450017-BD1	450023-BD1	450026-BD1
● Coarse				450009-BD1	450015-BD1	450021-BD1	
● Extra-coarse							

Flame



	2.9	6.2	7.8	9.8	3.7	6.7	7.8	9.8	6.4	7.2
Head Length	2.9	6.2	7.8	9.8	3.7	6.7	7.8	9.8	6.4	7.2
Diameter	008	012	012	014	014	012	016	016	018	014
● Super-fine	450081-BD1	450085-BD1	450093-BD1				450122-BD1		450132-BD1	
● Fine	450079-BD1	450083-BD1	450091-BD1					450124-BD1	450130-BD1	
● Regular		450084-BD1	450092-BD1	450097-BD1	450101-BD1	450108-BD1	450121-BD1	450125-BD1	450131-BD1	450136-BD1
● Coarse		450082-BD1	450090-BD1		450099-BD1	450107-BD1	450119-BD1	450123-BD1	450129-BD1	450134-BD1
● Extra-coarse				450098-BD1						

Flame (Short Shank)



	6.2	7.8	7.2
Head Length	6.2	7.8	7.2
Diameter	012	012	014
● Super-fine			
● Fine			
● Regular	450567-BD1		
● Coarse		450570-BD1	450582-BD1
● Extra-coarse			

Flat-End Taper



	9.8	9.8	5.8	9.8	7.8	7.3	9.8	7.8	7.8	8.8
Head Length	9.8	9.8	5.8	9.8	7.8	7.3	9.8	7.8	7.8	8.8
Diameter	014	018	016	018	014	018	018	018	018	016
● Super-fine		450305-BD1								
● Fine	450300-BD1								450394-BD1	
● Regular	450301-BD1	450304-BD1		450331-BD1	450354-BD1	450360-BD1	450381-BD1	450391-BD1		450398-BD1
● Coarse	450299-BD1	450302-BD1	450322-BD1		450352-BD1	450358-BD1	450379-BD1	450389-BD1	450393-BD1	450396-BD1
● Extra-coarse										

Flat-End Taper



	7.2	8.8	2.8
Head Length	7.2	8.8	2.8
Diameter	023	018	021
● Super-fine			
● Fine			
● Regular	450413-BD1	450416-BD1	
● Coarse	450411-BD1	450414-BD1	450160-BD1
● Extra-coarse			

Inverted Cone



	0.9	1.1	1.7
Head Length	0.9	1.1	1.7
Diameter	010	012	018
● Super-fine			
● Fine			
● Regular	450143-BD1	450147-BD1	450149-BD1
● Coarse		450146-BD1	
● Extra-coarse			

Needle



	9.9	7.1
Head Length	9.9	7.1
Diameter	021	025
● Super-fine		
● Fine		
● Regular		
● Coarse	450356-BD1	450178-BD1
● Extra-coarse		

Occlusal

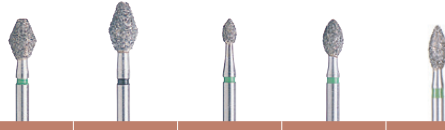

	4.6	5.6	2.8	4.0	5.2
Head Length	4.6	5.6	2.8	4.0	5.2
Diameter	033	035	018	025	023
● Super-fine					450297-BD1
● Fine			450285-BD1		450295-BD1
● Regular	450184-BD1	450188-BD1	450286-BD1	450293-BD1	450296-BD1
● Coarse	450182-BD1	450186-BD1		450292-BD1	450294-BD1
● Extra-coarse		450189-BD1			450298-BD1

Occlusal (Short Shank)



	5.2
Head Length	5.2
Diameter	023
● Super-fine	
● Fine	
● Regular	450597-BD1
● Coarse	
● Extra-coarse	

Round



	0.5	0.9	0.9	1.1	1.1	1.2	1.4	1.5	1.9	1.3
Head Length	0.5	0.9	0.9	1.1	1.1	1.2	1.4	1.5	1.9	1.3
Diameter	009	014	014	016	016	018	020	020	025	020
● Super-fine				450064-BD1						
● Fine		450056-BD1		450062-BD1					450074-BD1	
● Regular	450054-BD1	450057-BD1					450069-BD1		450075-BD1	450077-BD1
● Coarse		450055-BD1	450059-BD1	450061-BD1	450066-BD1	450067-BD1	450068-BD1	450071-BD1		
● Extra-coarse				450065-BD1						

Round End Taper (Short Shank)



	8.8	6.2	8.0	7.8
Head Length	8.8	6.2	8.0	7.8
Diameter	021	016	018	022
● Super-fine				
● Fine				
● Regular	450605-BD1	450615-BD1		450628-BD1
● Coarse	450603-BD1	450613-BD1	450617-BD1	450627-BD1
● Extra-coarse				

Round End Taper



	4.0	3.7	9.8	6.2	8.8	10.3	6.2	8.0	7.8	8.8	9.0
Head Length	4.0	3.7	9.8	6.2	8.8	10.3	6.2	8.0	7.8	8.8	9.0
Diameter	018	011	014	014	016	016	016	018	016	018	018
● Super-fine							450370-BD1				
● Fine	450219-BD1						450368-BD1				450401-BD1
● Regular	450220-BD1		450310-BD1	450334-BD1	450339-BD1	450342-BD1	450369-BD1	450374-BD1	450378-BD1	450387-BD1	450402-BD1
● Coarse	450218-BD1	450306-BD1	450308-BD1	450332-BD1	450337-BD1	450340-BD1	450367-BD1	450372-BD1	450376-BD1	450385-BD1	450400-BD1
● Extra-coarse				450336-BD1			450371-BD1	450375-BD1		450388-BD1	450403-BD1



	8.1	9.0	7.8	8.8
Head Length	8.1	9.0	7.8	8.8
Diameter	018	018	022	021
● Super-fine				
● Fine				
● Regular		450410-BD1	450419-BD1	450423-BD1
● Coarse	450404-BD1	450408-BD1	450417-BD1	450421-BD1
● Extra-coarse			450420-BD1	450424-BD1

Straight Cylinder



	1	2	3	4	5	6	7	8	9	10	11
Head Length	4.0	4.0	6.0	8.0	7.6	8.0	2.7	3.7	3.7	3.7	3.2
Diameter	012	018	014	012	012	016	009	012	012	016	016
● Super-fine											
● Fine						450215-BD1					
● Regular	450196-BD1			450209-BD1	450213-BD1	450216-BD1					450249-BD1
● Coarse		450200-BD1	450202-BD1		450211-BD1	450214-BD1	450239-BD1	450242-BD1	450244-BD1	450247-BD1	
● Extra-coarse						450217-BD1					



	1	2	3	4	5	6	7	8	9	10	11
Head Length	4.8	2.9	4.0	4.8	6.2	6.2	7.3	8.7	7.9	6.8	7.5
Diameter	010	010	014	010	012	012	016	016	012	012	014
● Super-fine											
● Fine		450255-BD1	450259-BD1								
● Regular	450253-BD1	450256-BD1	450260-BD1	450262-BD1	450263-BD1	450268-BD1	450271-BD1	450275-BD1			
● Coarse	450251-BD1	450254-BD1	450258-BD1	450261-BD1	450264-BD1	450267-BD1	450270-BD1	450274-BD1	450277-BD1	450278-BD1	450279-BD1
● Extra-coarse						450269-BD1		450276-BD1			



	1	2
Head Length	7.9	8.0
Diameter	012	021
● Coarse	450281-BD1	450282-BD1
● Extra-coarse		

Tapered



	1
Head Length	3.5
Diameter	009
● Super-fine	
● Fine	
● Regular	450031-BD1
● Coarse	
● Extra-coarse	

Wheel



	1	2	3	4
Head Length	1.0	1.0	0.7	1.0
Diameter	040	047	060	047
● Super-fine				
● Fine				
● Regular	450448-BD1	450458-BD1	450492-BD1	
● Coarse	450446-BD1	450449-BD1	450491-BD1	450631-BD1*











* Short Shank

3.1 Burs — BluWhite diamonds — Composite finishing

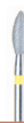
Grit type

Grit	Colour Band	Microns
Compo Ultra-fine	● Violet	17–23
Compo Fine	● Yellow	34–40



											
Head Length	2.9	4.0	5.0	6.9	4.6	4.9	6.0	4.1	10.2	1.3	2.1
Diameter	014	021	021	010	023	023	016	010	016	016	025
● Compo Ultra-fine	450240-CF1	450241-CF1	450230-CF1	450231-CF1	450237-CF1	450238-CF1	450210-CF1	450232-CF1	450235-CF1	450229-CF1	
● Compo Fine	450172-CF1		450163-CF1	450164-CF1	450170-CF1	450171-CF1	450157-CF1	450165-CF1	450168-CF1	450627-BD1	450180-CF1

3.2 Impression materials — VPS

Take 1™ Advanced™

VPS impression material

Take 1™ Advanced™ impression material offers an optimum combination of physical properties – strength, elasticity, dimensional stability – and the ability to register detail in any environment.

Standing apart from ordinary impression materials that focus on a single attribute, the chemistry of Take 1 Advanced delivers features that enhance overall performance:

- Hydrophilic dental wash material. Displaces intraoral fluids to produce impressions with great detail and no voids or gaps
- Very good in tear strength and elongation
- Very good dimensional stability
- Strong, flexible material stretches around undercuts without tearing or distorting
- Widest selection of viscosities, set times and delivery methods

Take 1™ Advanced™ Putty Fast Set

REF/Part No. 34144

1 Putty Base Fast Set (400g), 1 Putty Catalyst Fast Set (400g), 2 Putty Scoops, 18 Putty Spacers

Take 1™ Advanced™ — Volume Refills

REF/Part No.

Each pack contains: 2 x 380ml, 2 x bayonet rings

Take 1 Advanced Tray Volume Fast Set	34963
Take 1 Advanced Tray Volume Regular Set	34962

Take 1™ Advanced™ — 2-Cartridge Refills

REF/Part No.

Each pack contains: 2 x 50ml Cartridge, 6 Large Mixing Tips. Regular Body Wash and Light Body Wash contain 6 Small Mixing Tips and 6 Small Intra-Oral Tips. Bite Registration contains 6 Large Mixing Tips and 6 Bite Registration Intra-Oral Tips.

Take 1 Advanced — Light Body Wash Fast Set	34149
Take 1 Advanced — Light Body Wash Regular Set	34150
Take 1 Advanced — Regular Body Wash Fast Set	34155
Take 1 Advanced — Regular Body Wash Regular Set	34156
Take 1 Advanced — Medium Fast Set	34152
Take 1 Advanced — Medium Regular Set	34153
Take 1 Advanced — Tray Fast Set	34158
Take 1 Advanced — Tray Regular Set	34159



Take 1™ Advanced™ Putty Fast Set



Take 1™ Advanced™ — Volume Refills



Take 1™ Advanced™ — 2-Cartridge Refills

Take 1™ Advanced™ Bite Registration

Take 1™ Advanced™ Bite Registration complements the Take 1™ Advanced portfolio to provide a complete solution within a single family of products.

- The material is uniform and free of voids
- Creates great contact
- Reproduces anatomical detail with accuracy

Take 1™ Advanced™ Bite Registration

REF/Part No. 34148

2x 50ml Cartridge, 6 Large Mixing Tips, 6 Bite Registration Intra-Oral Tips



Take 1™ Advanced™ Bite Registration

3.2 Impression materials — Alginate & alginate alternative material

Take 1™ Alginate

Alginate impression material

Take 1™ Alginate combines clinical versatility with exceptional ease of use. Its chromatic colour-change property ensures timely procedure control and its elasticity, dimensional stability, accurate detail reproduction and 120-hour (at 100% humidity) pouring time provide consistently reliable results.

Take 1™ Alginate — Jar

REF/Part No. 33342

1x Jar (500g), 1x Powder and 1x Liquid Measure

Take 1™ Alginate — Bag

REF/Part No. 33343

20x 450g bags, 5x Powder and 5x Liquid Measures



Take 1™ Alginate

3.2 Impression materials — Addition Silicones

Extrude™

Extrude™ is an addition silicone impression system available in five viscosities, including a putty, to provide all the options needed for accurate results with any technique.

Extrude™ Wash — Light Blue

REF/Part No.

Very low-viscosity material used in combination with Putty for the putty/wash technique, or with Extra for the double-mix technique

2 x 50 ml Cartridge Refill, 6 Mixing Tips 28418

16 x 2 REF/Part No. 28418 (Mixing Tips included) 28419

Extrude™ Medium — Green

REF/Part No.

Provides excellent flow as well as sufficient body for use as a tray material

2 x 50 ml Cartridge Refill, 6 Mixing Tips 28416

16 x 2 REF/Part No. 28416 (Mixing Tips included) 28417

Extrude™ Extra — Purple

REF/Part No.

High viscosity material for use individually or with any other Extrude impression material. Especially recommended for use with Wash for the double-mix technique

2 x 50 ml Cartridge Refill, 6 Mixing Tips 28414

16 x 2 REF/Part No. 28414 (Mixing Tips included) 28415

Extrude™ XP Putty

REF/Part No.

The ideal tray material for both simultaneous and two-step putty wash techniques. Its thixotropic nature will drive any syringe material subgingivally for ideal tissue displacement and excellent detail

520 ml putty (2 jars), Scoops and Spacers 27877



Extrude™



Extrude™ XP Putty

3.2 Impression materials — Trays

Kwik Tray

Kwik Trays are adjustable, perforated, aluminium trays for crown, bridge and inlay quadrant impressions.

Kwik Tray

REF/Part No. 61163

24 x trays



Kwik Tray

3.2 Impression materials — Rubber Base

Permlastic™

Permlastic™ is a rubber base (polysulfide, condensation-cured, elastomeric) impression material available in three viscosities.

- **Regular Permlastic** is recommended for partial or full denture impressions because it has a high degree of flow that will register the finest detail.
- **Light-Bodied Permlastic** is the most free-flowing of the Permlastic materials. It is excellent for inlay and fixed-bridge impressions.
- **Heavy-Bodied Permlastic** is formulated for use whenever a stiffer material is indicated. The heavy body consistency results in optimum compression of the Light-Bodied Permlastic in a double-mix, copper-band impression.



Permlastic™

Permlastic™ — Standard Pack

REF/Part No.

1 Tube Base (Heavy body = 2 Tubes), 1 Tube Catalyst, 1 Mixing Pad

Permlastic — Heavy Body — 170 g	60099
Permlastic — Regular Body — 230 g	60101
Permlastic — Light Body — 225 g	60102

Permlastic™ — Accessories

REF/Part No.

Permlastic Adhesive, 60ml Bottle	60098
----------------------------------	-------

3.2 Impression materials — Thermoplastic Impression Compound

Impression Compound

Impression Compound is a thermoplastic impression material available in cakes – for full or partial impressions – and sticks – for copper-band impressions and to add to the periphery of an impression tray. Each coloured variant has a controlled working temperature.

Impression Compound — Pack of 8 Cakes (227 g)

REF/Part No.

Green (temp. 50 °C)	00441
Red (temp. 55 °C)	00429

Impression Compound — Pack of 15 Sticks (113 g)

REF/Part No.

Green (temp. 50 °C)	00444
Grey (temp. 53 °C)	00455
Red (temp. 55 °C)	00432

3.2 Impression materials — Functional impression

F.I.T.T.

F.I.T.T. (Functional Impression Tissue Toner) is a gel that remains soft enough to produce a functional impression. It can be worn for several days to help restore injured tissue and eliminate post-delivery adjustments. It is easy-to-mix and continues to flow under pressure for several days.

F.I.T.T. — Standard Pack REF/Part No. 61127

100g Powder, 100 ml Liquid, 15 ml Separator, 14 Plastic Cups for measurement and mixing, 2 Liquid Measures

F.I.T.T. — Refills REF/Part No.

F.I.T.T. Liquid, 100ml Bottle	61132
F.I.T.T. Powder, 100g Bottle	61144
Plastic Cups for measurement and mixing (14 Cups)	61141

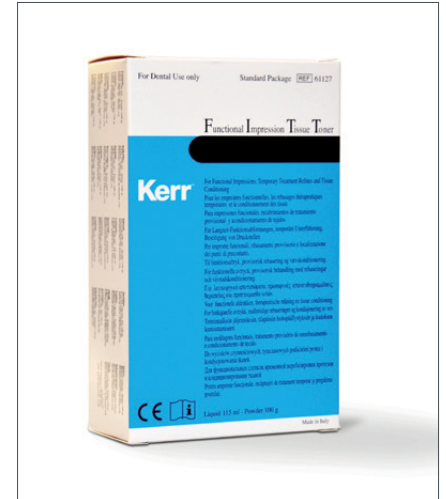

F.I.T.T. — Standard Pack

3.2 Impression materials — Bite registration wax

Occlusal Indicator Wax

Occlusal Indicator Wax is a high-spot indicator for the checking of occlusal relationships.

Occlusal Indicator Wax REF/Part No. 00655

180 indicator Strips, 1 waterproof pencil

3.2 Impression materials — Waxes

Blue Inlay Casting Wax

Blue Inlay Casting Wax is a superior wax for build up, which softens in hot water and can be carved easily to produce excellent results.

Blue Inlay Casting Wax REF/Part No.

Blue, regular — Pack of 15 Sticks (approx. 34g)	00474
Blue, regular — Pack of 120 Sticks (approx. 250g)	00475



Blue Inlay Casting Wax

Sticky Wax

Sticky Wax is a hard, fast-setting wax. Used to repair a wax pattern and for the welding of waxes. It is excellent for joining sprues to sprue bases.

Sticky Wax	REF/Part No.
Sticky Wax — Pack of 12 Sticks (approx. 27.7 g)	00623
Sticky Wax — Pack of 120 Sticks (approx. 277 g)	00625



Sticky Wax

Boxing Wax

In boxing a full denture impression, a Boxing Wax Stick is placed around the impression just below the peripheral border. A Boxing Wax Strip is then attached to this beading. Both waxes are tacky, resulting in great adhesion without application heat.

Boxing Wax	REF/Part No.
Boxing Wax — Pack of 42 Sticks (approx. 170 g)	00609
Boxing Wax — Pack of 35 Strips (approx. 454 g)	00608



Boxing Wax

Orthodontic Tray Wax

Orthodontic Tray Wax is a soft white plastic wax stick for orthodontic use in extension of periphery, post damming and stops for impression trays.

Orthodontic Tray Wax	REF/Part No.
Orthodontic Tray Wax — Pack of 48 Sticks (140 g)	09246

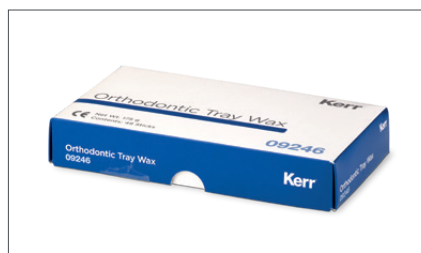

Orthodontic Tray Wax

Disclosing Wax

Disclosing Wax is a creamy wax used to repair wax pattern defects. It can also be used to determine the fit of full and partial dentures in relation to supporting tissue.

Disclosing Wax	REF/Part No.
Disclosing Wax — Opaque 57 g	00610



Disclosing Wax

3.2 Impression materials — Accessories

Accessories for Take 1 Advanced, AlgiNot, Extrude, Alginator and Volume Machine

Dynamic Mixing Tips for Volume

REF/Part No. 112623

50 Tips/Yellow, 2 Bayonet Rings for AlgiNot and Take 1

Accessories	REF/Part No.
Small Mixing Tips (48 Tips)	29363
Large Mixing Tips (48 Tips)	29333
Gun dispenser	28747
Intra-Oral Tips (100 Tips) Yellow	27517
Intra-Oral Mixing Tips (100 Tips) Large	20731
Putty spacers (18)	09526

Mixing Pads

The mixing pads are made of plastic-coated special paper, which is easily detached from the pad.

Mixing Pads

Mixing Pads — 100 x 120 mm (for Permlastic)

REF/Part No.

60675



Mixing Pads

Solitine

Solitine is an effective solvent for all thiokol, silicone and zinc oxide-eugenol impression materials, to remove impression material from the skin, spatula and other instruments.

Solitine

Solitine — 250ml Bottle

REF/Part No.

60084



Solitine

3.2 Impression materials — Retraction cords

GingiBRAID+™

GingiBRAID+ is a specially treated, impregnated or non-impregnated retraction cord braided together for quick absorption, providing immediate and effective use. The braided retraction material is made of cotton fibre that will not split or collapse in the sulcus.

- Solid cord that provides a strong physical retraction
- Can be used with any type of packing instrument
- Resists deformation and penetration by instrument
- Fast-acting haemostasis

GingiBRAID+™ ShortCut™

Short-Cut is the hassle-free, scissors-free way to dispense the GingiBRAID+ retraction cord. It has a built-in cord cutter and a dial. Each click of the dial delivers 1 cm of cord.

GingiBRAID+™ — Impregnated — 183 cm				
Size	0a — Fine	1a — Small	2a — Medium	3a — Large
Colour Code	Yellow	Yellow/Purple	Yellow/Green	Yellow/Pink
Al. Potassium Sulphate (mg/In.)	0.15-0.35	0.2-0.5	0.5-0.8	0.8-1.5
REF/Part No.	13210	13211	13212	13213

GingiBRAID+™ — Non-impregnated — 183 cm				
Size	0n — Fine	1n — Small	2n — Medium	3n — Large
Colour Code	White	White/Purple	White/Green	White/Pink
REF/Part No.	13217	13214	13215	13216

GingiBRAID+™ — ShortCut™ — Impregnated — 183 cm			
Size	0a — Fine	1a — Small	2a — Medium
Colour Code	Yellow	Yellow/Purple	Yellow/Green
Al. Potassium Sulphate (mg/In.)	0.15-0.35	0.2-0.5	0.5-0.8
REF/Part No.	13730	13731	13732

Size	0n — Fine	1n — Small
Colour Code	White	White/Purple
REF/Part No.	13740	13741



GingiBRAID+™ — Impregnated



GingiBRAID+™ — Non-Impregnated



GingiBRAID+™ — ShortCut — Impregnated



GingiBRAID+™ — ShortCut — Non-Impregnated

GingiKNIT+™

GingiKNIT+™ knitted retraction cord is constructed by knitting many tiny loops together to form a long interlocking chain. GingiKNIT+ places easily without fraying or memory, and conforms to the sulcus with a gentle, outward force.

GingiKNIT+ is available both as non-impregnated or impregnated with aluminium potassium sulphate. Each bottle contains 183 cm of knitted cord.

GingiKNIT+™ — Impregnated — 183 cm

Size	000a - Extra Fine	00a — Fine	0a — Small	1a — Medium	2a — Large
Colour Code	Yellow	Yellow/Black	Yellow/Orange	Yellow / Orange-Black	Yellow/Red
Al. Potassium Sulphate (mg/In.)	0.05-0.15	0.2-0.5	0.5-0.8	0.8-1.5	0.8-1.5
REF/Part No.	13508	13509	13510	13511	13512

GingiKNIT+™ — Non-Impregnated — 183 cm

Size	000a - Extra Fine	00n — Fine	0n — Small	1n — Medium	2n — Large
Colour Code	Yellow	Yellow/Black	Yellow/Orange	Yellow / Orange-Black	Yellow/Red
REF/Part No.	13498	13499	13500	13501	13502



GingiKNIT+™ — Impregnated



GingiKNIT+™ — Non-Impregnated

GingiGEL™

GingiGEL™ retraction cord is a gel-coated braid made of synthetic fibre and packaged in a haemostatic gel containing 20% buffered aluminium chloride. The GingiGEL braid is completely saturated and has an extra layer of medicament coating. The saturation allows for easy placement and immediate haemostatic results. The gel keeps the braid soft and flexible.

GingiGEL+™ — 183 cm

Size	1 — Small	2 — Medium
Colour Code	Yellow	Yellow/Purple
REF/Part No.	13165	13166



GingiGEL™

Styptin™

Styptin™ is a fast-acting, 20% buffered aluminium chloride dental haemostatic agent in a lubricating base. Its blue colouring helps you to see where the solution has been placed. The increased viscosity prevents the solution from migrating from the site. Styptin haemostatic solution is available in a squeeze bottle to minimise the risk of cross-contamination.

Styptin™

REF/Part No.

Styptin - Cranberry Flavour — 30ml Refill Bottle	13156
Styptin - Cranberry Flavour - 15ml Squeeze Bottle	13157



Styptin™

3.3 Temporisation

Temp-Bond™

Temporary attachment. Permanent reliability.

Discover the range of Temp-Bond™ temporisation solutions:

High bond strength.

Excellent bond strength, yet easy-to-remove when desired. Designed to prevent leakage.

Easy-to-remove.

Easy removal of cement minimises potential damage to the prep or temporary

Flexible delivery choices.

Temp-Bond Original, Temp-Bond Clear and Temp-Bond NE are available in an automix syringe. Moreover, Temp-Bond and Temp-Bond NE are also available in Unidose and tubes, offering flexible delivery options.

Flows and mixes easily.

Delivers optimal consistency for solid, complete seating of restorations.



Temp-Bond™

Temporary cement

Temp-Bond™ is a self-curing zinc-oxide eugenol-based temporary cement indicated for temporary crowns, bridges or splints, and for trial cementing permanent restorations. Its smooth flow allows for exceptional handling and results in effortless and complete restoration seating.

Temp-Bond™ — Automix Syringe

REF/Part No. 33684

2x 11.8g Syringe, 20x Mixing Tips

Temp-Bond™ — Introductory Pack (with Modifier)

REF/Part No. 60058

1x 50g Tube Base, 1x 15g Tube Accelerator, 1x 13g Tube Modifier, 1x Mixing Pad

Temp-Bond™ — Standard Pack (without Modifier)

REF/Part No. 61087

1x 50g Tube Base, 1x 15g Tube Accelerator, 1x Mixing Pad

Temp-Bond™ — Unidose

REF/Part No. 31377

50x 2.4g Unidose

Temp-Bond™ — Refills

REF/Part No.

Temp-Bond - 50g Tube Base

60254

Temp-Bond - 15g Tube Accelerator

60255

Temp-Bond - 13g Modifier

61081

Mixing Pads — 70x 100 mm

60913



Temp-Bond™ — Automix Syringe



Temp-Bond™ — Standard Pack



Temp-Bond™ — Unidose

Temp-Bond™ NE™

Non-eugenol temporary cement

Temp-Bond™ NE™ non-eugenol temporary zinc-oxide cement offers an option for patients allergic to eugenol. It does not inhibit the polymerisation of permanent resin cements and acrylic temporaries, yet provides the same flow and retentive properties of Temp-Bond.

Temp-Bond™ NE™ — Automix Syringe

REF/Part No. 33685

2x 11.8g Syringe, 20x Mixing Tips

Temp-Bond™ NE™ — Standard Pack

REF/Part No. 60256

1x 50ml Tube Base, 1x 15ml Tube Accelerator, 1x Mixing Pad

Temp-Bond™ NE™ — Unidose

REF/Part No. 31973

50x 2.4g Unidose

Temp-Bond™ NE™ — Refills

REF/Part No.

Mixing Pads — 70x 100 mm

60913



Temp-Bond™ NE™ — Automix Syringe



Temp-Bond™ NE™ — Standard Pack



Temp-Bond™ NE™ — Unidose

Temp-Bond™ Clear™

Translucent provisional cement

Resin-based Temp-Bond™ Clear™ is the most translucent provisional cement available, ensuring superior aesthetics. Temp-Bond Clear offers dual curing for added security and flexibility, ease of handling, excellent mechanical retention and easy removal from preparations. Temp-Bond Clear is eugenol-free, allowing it to be used with resin luting cements.



Temp-Bond™ Clear™

Temp-Bond™ Clear™ — Automix Syringe	REF/Part No. 33351EU
-------------------------------------	----------------------

1x 6g Syringe; 10x Mixing Tips

Temp-Bond™ Clear™ — Accessories	REF/Part No.
---------------------------------	--------------

Temp-Bond Clear – 50x Automix Tip Refill	33361
--	-------

OptiClean™

Temporary cement and debris removal

OptiClean™ is a rotary instrument with flexible coating and a 1.65 mm tip diameter. It enables fast and easy removal of temporary dental cement and debris thanks to the optimised abrasive particles that work efficiently but with minimal abrasion. It also gives clear view of the working surface since no paste or pumice slurry is required. Highly hygienic because it is single-use.



OptiClean™

OptiClean™ Kit	REF/Part No. 950
----------------	------------------

12x OptiClean instruments

Temphase

Temporary crown and bridge material

Automix temporary crown and bridge resin based material with two distinct set times is ideal for both short- and long-term temporisation.



Temphase

Temphase — 72g Refill Cartridge with 12 Mixing Tips	REF/Part No.
---	--------------

Temphase Regular Set — A1	29366
Temphase Regular Set — A2	28070
Temphase Regular Set — A3.5	28071
Temphase Fast Set — A1	29367
Temphase Fast Set — A2	28655
Temphase Fast Set — A3.5	28658

Temphase — Accessories	REF/Part No.
------------------------	--------------

Temphase — 48 Mixing Tips	28075
Temphase — Extruder Gun	28747

3.4 Bonding agents

OptiBond™ Family

A rich history of clinical success has established the OptiBond brand as the reference point for all adhesion needs.

It offers a complete range to cover any procedural preference and etching technique, with a firm commitment to providing great strength, versatility and protection against microleakage at every step of the way.

All OptiBond adhesives are infused with patented GPDM monomer, known as the “Gold Standard” in adhesion. The GPDM ensures more effective and reliable adhesion than other adhesive monomers to both the tooth structure and the resin material:

- An acidic phosphate group effectively anchors the adhesive to the hydrophilic surface of the tooth.
- The presence of more methacrylate functional groups compared to other adhesive monomers, such as MDP, allows a more effective interface with the hydrophobic resin.

This combination creates better compatibility with both tooth and resin material and an overall higher bond strength.



3.4 Bonding agents — Universal platform

OptiBond™ eXTRa Universal

Two-component universal adhesive

Introducing OptiBond eXTRa Universal, the bonding agent from KaVo Kerr with unique Smart pH technology and patented formula enriched with GPDM monomer and the Ternary Solvent System.

- Outstanding compatibility with virtually all types of cements, composites and core build-up materials, eliminating the need for auxiliary product
- Easy and consistent two-bottle protocol with any etching technique
- Full reliability afforded by OptiBond technology, known as the “Gold Standard” in adhesion



Bond strength to enamel and dentine

OptiBond™ eXTRa Universal yields outstanding results ensuring superior bond strength compared to leading competitors* on both dentine and enamel. This offers a consistent outcome under different etching techniques and substrates.

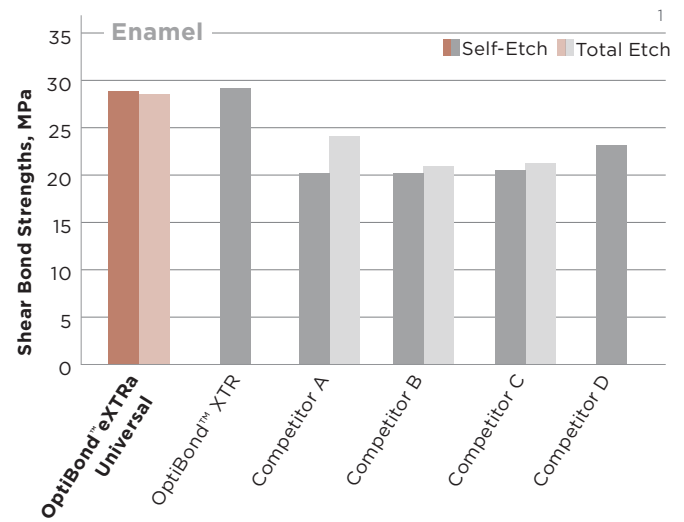
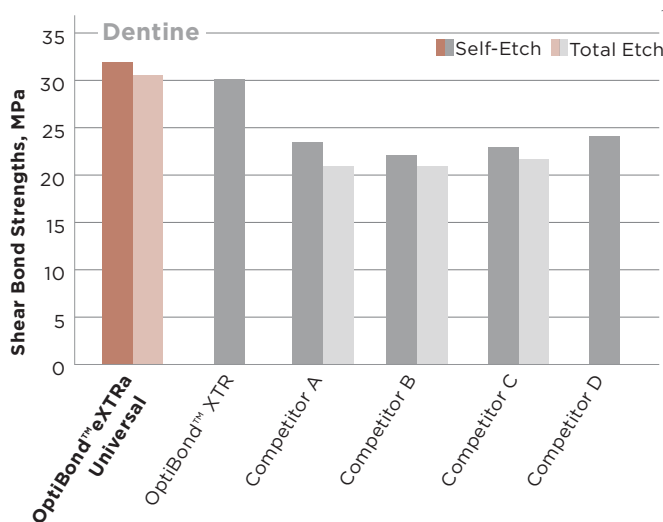

Imperceptible film thickness

The unique formula has a very low filler load (only 15%), producing a film so thin it is not visible to the naked eye. The result is highly aesthetic without, however, compromising strength.

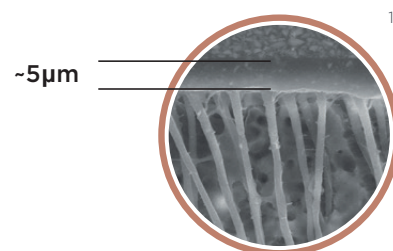

OptiBond™ eXTRa Universal

Effective plug and seal action

The Primer component is very acidic and hydrophilic, resulting in unique nano-etching capability and outstanding dentinal tubule penetration. The Adhesive component is hydrophobic, offering efficient polymerisation to boost mechanical strength, bond durability and marginal integrity.

Uncut enamel - microscope view 50,000x

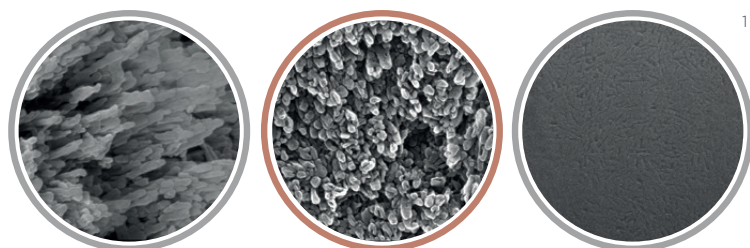

Kerr Gel Etchant

OptiBond eXTRa Universal
Self-Etch mode

Leading Competitor
Self-Etch mode

Dentine tubules - microscope view 20,000x

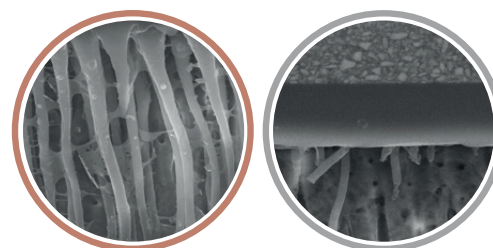

OptiBond eXTRa Universal
Self-Etch mode

Leading Competitor
Self-Etch mode

* Compared to Scotchbond™ Universal, Prime&Bond™ Elect, Adhese™ Universal, Clearfil SE Protect, Clearfil Universal Bond Quick, Futurabond U to Dentine and enamel on Self-Etch and Total Etch mode; compared to Clearfil SE Bond 2 to Dentine and enamel on Self-Etch Mode. Samples were prepared per individual manufacturer's instruction for use.

High shear bond strength and full compatibility

The combination of OptiBond™ eXTRa Universal and NX3 universal adhesive cement proved to deliver superior bond strength to dentine without the need for auxiliary products, compared to leading competitors**. So you can experience predictable outcomes with the simplicity of a consistent protocol.

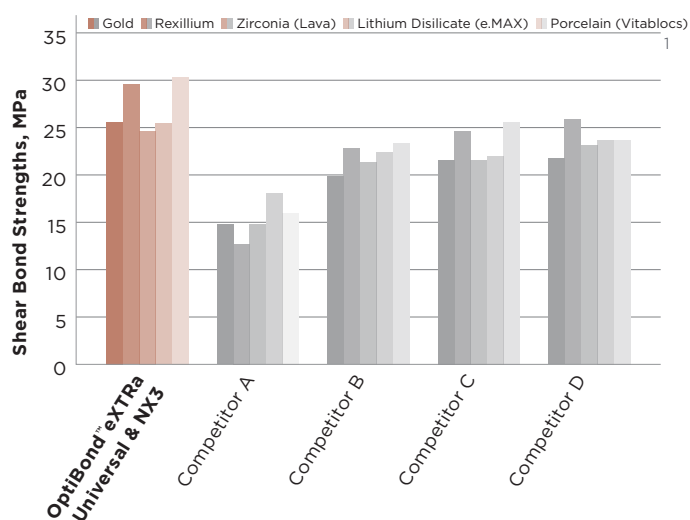
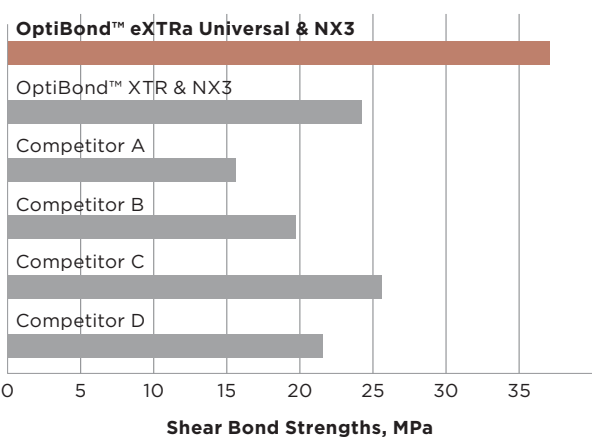

OptiBond™ eXTRa Universal

REF/Part No.

OptiBond™ eXTRa Universal – Bottle Kit – 10 ml	36658
OptiBond™ eXTRa Universal – Unidose Kit – 100 pcs	36659
OptiBond™ eXTRa Universal – 5 ml Bottle Refill – Primer	36660
OptiBond™ eXTRa Universal – 5 ml Bottle Refill – Adhesive	36661
Applicators – 50 Applicators x 4 Boxes	24680



OptiBond™ eXTRa Universal – Bottle Kit

1. Data available on request

OptiBond™ Universal

Single-component universal dental adhesive

OptiBond™ Universal is the one-bottle dental bonding agent that combines the reliability of patented OptiBond GPDM technology with the ease of use of a universal solution.

It offers reliable bond strength to all surfaces and substrates, in any etching technique. Efficacy and flexibility coming together at last.

- One bottle. One coat
- Proven strength
- Complete versatility
- Protection against post-operative sensitivity



Bond strength to enamel and dentine

OptiBond Universal yields effective bond strength on both dentine and enamel. It creates maximum flexibility by demonstrating great results under different etching techniques.

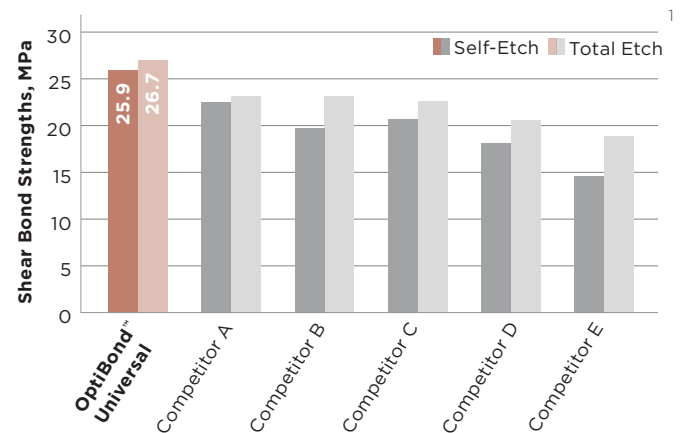
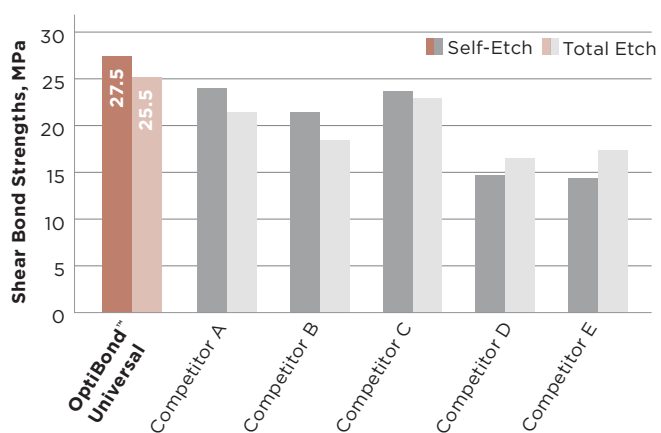

Bond strength to various dental substrates

The combination of OptiBond Universal and NX3 universal adhesive cement facilitates high levels of indirect bond strength to various dental substrates, without the need for a separate ceramic or metal primer.

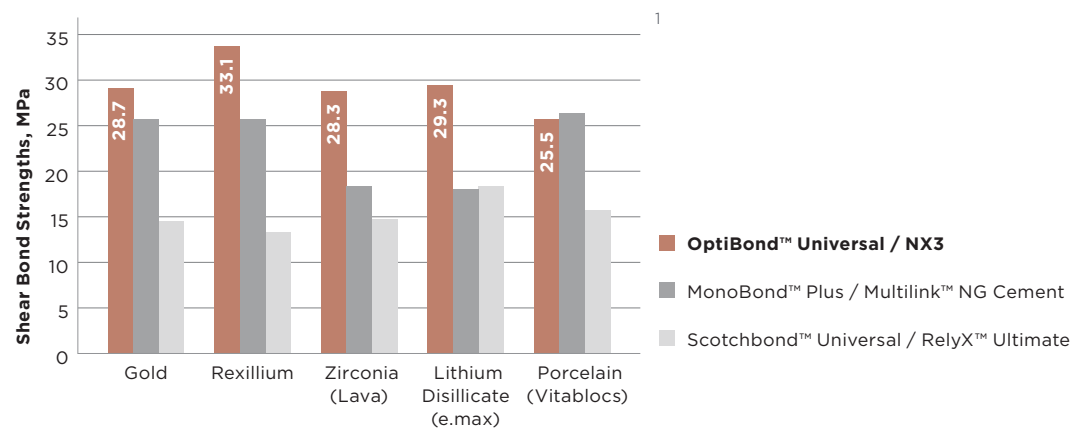

Bond strength with cement

Using OptiBond Universal and NX3 cement together enhances bond compatibility and promotes high levels of indirect bond strength to dentine.

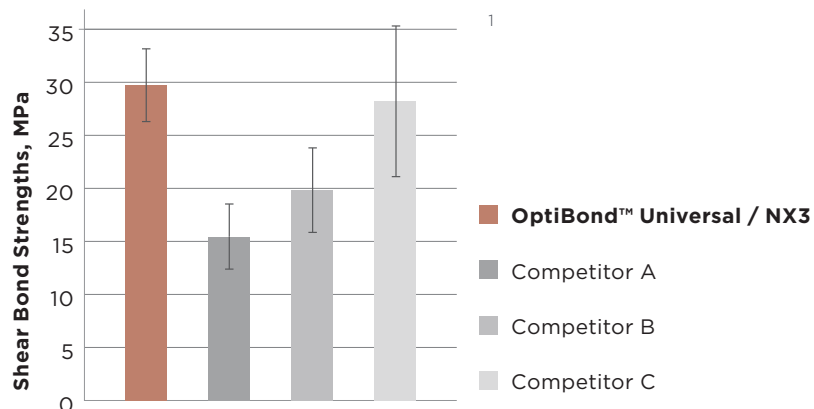

OptiBond™ Universal	REF/Part No.
OptiBond™ Universal — Bottle Kit — 5 ml	36517
OptiBond™ Universal — Unidose Kit — 100 pcs	36518
OptiBond™ Universal — 5 ml Bottle Refill	36519
Applicators — 50 Applicators x 4 Boxes	24680

1. Data available on request



OptiBond™ Universal — Bottle Kit

3.4 Bonding agents — Etch and rinse platform

OptiBond™ FL

Filled, light-cure total-etch dental adhesive

Since its launch in 1995, OptiBond™ FL has established the standard in adhesive technology, validated by long-term clinical studies and recommended as the gold standard by leading dental universities worldwide.

- Unique structural bond with 48% filler load
- Efficient application flow - one-coat primer, one-coat adhesive, one-light curing; wet or dry preparations
- High radiopacity, making X-ray detection easy
- Availability in bottle and Unidose delivery
- Proven long-term performance



OptiBond™ FL	REF/Part No.
OptiBond™ FL — Bottle Kit — 16 ml	26684 E
OptiBond™ FL — Unidose Kit — 50 pcs	33352 E
OptiBond™ FL — 8 ml Bottle Refill — Primer	25881 E
OptiBond™ FL — 8 ml Bottle Refill — Adhesive	25882 E



OptiBond™ FL — Bottle Kit

OptiBond™ Solo™ Plus

Single component total-etch dental adhesive

OptiBond™ Solo™ Plus is a total-etch, single-component dental adhesive for virtually every clinical application. Ethanol-based, 15% filled with proprietary 0.4µm filler, OptiBond Solo Plus actually reinforces dentine tubules at much greater depths than unfilled or nano-filled systems. This means improved long-term stability and great bond strengths with direct and indirect applications.



OptiBond™ Solo™ Plus	REF/Part No.
OptiBond™ Solo™ Plus — Bottle Kit — 10 ml	29670
OptiBond™ Solo™ Plus — 5 ml Bottle Refill	29692
OptiBond™ Solo™ Plus — Unidose Refill pack — 100 pcs	29669 E



OptiBond™ Solo™ Plus — Bottle Kit

3.4 Bonding agents — Gel Etchant

Gel Etchant

37.5% phosphoric acid gel

Designed for dentine and enamel etching, the vibrant purple colour of the Kerr Gel Etchant provides excellent visibility during placement. The viscosity ensures that there will be no running or separation. Rinses clean and easily with minimum effort and features the convenience of syringe delivery.

Gel Etchant	REF/Part No.
Gel Etchant Pack — 3x 3g Syringes, 30 Tips	31297
Gel Etchant Economy Pack - 30g Syringe, 2 empty intraoral Syringes, 30 Tips	34632
30 Disposable Gel Etchant Tips	26909



Gel Etchant Pack



Gel Etchant Economy Pack

OptiBond™ selection guide

	OptiBond™ FL Two-Component, 48% Filled Adhesive	OptiBond™ Solo™ Plus Single-Component, Total-Etch Adhesive	OptiBond™ exTRa Universal Two-Component Universal Adhesive	OptiBond™ Universal Single-Component Universal Adhesive
Indications				
Direct	✓	✓	✓	✓
Indirect	✗ ¹	✓	✓	✓
Anterior	✓	✓	✓	✓
Posterior	✓	✓	✓	✓
Substrates				
Dentine/Enamel/Uncut Enamel	✓	✓	✓	✓
All Ceramics Including Lithium Disilicate Ceramic	✗ ¹	✓ ²	✓	✓
Metal-based Including Zirconia-based & Alumina-based	✗ ¹	✓	✓	✓
Inlay/Onlays	✗ ¹	✓	✓	✓
Core Build-up	✓	✓	✓	✓
Cementation of posts	✗ ¹	✓ ³	✓	✓ ³
Composite/Metal Repair	✓	✓	✓	✓
Porcelain Repair	✓	✓	✓	✓
Amalgam Sealing	✓	✓	✓	✓
Auxiliary products needed				
Gel Etchant	●	●	● ⁴	● ⁴
Silane	-	●	● ⁵	● ⁵
Metal Primer	-	● ⁵	● ⁵	● ⁵
Total Dark Cure Mode Capability for cementation	-	●	● ⁶	●
Bonding Compatibility				
Compatible with all Resin Cements & Core Build-up	-	● ³	● ⁷	● ³

Notes

1. Not available due to high film thickness
2. Use with Silane

3. Use only with NX3 cement

4. Optional

5. Not required

6. With NX3 Cement

7. Compatible with any resin cements

Legend

- ✓ Recommended.
- ✓ Secondary Recommendation.
- ✗ Not Recommended.

- Yes.
- Optional.
- No.

3.5 Composites — Universal

SimpliShade™

Simplified Universal Composite System

- Simplify Shade-matching**
 Shade selection made easier and faster. SimpliShade matches all 16 VITA classical shades with just 3 shades: Light, Medium, Dark.
- Adaptive Response Technology (ART)**
 The ART filler network, a proven technology found in Harmonize, helps you achieve lifelike restorations with exceptional strength and unmatched esthetics.
- Streamline Inventory Management**
 Save time and money with minimal shades to meet almost all your composite needs. Declutter your shelves, avoid the burden of re-ordering too many different part numbers, and reduce or eliminate expired products.
- Universal For All Cavity Classes**
 Use SimpliShade with confidence in all cavity classes without the need for a blocker, unlike other competitors.¹



Restorations That Shine

SimpliShade's smaller particle size of 50nm allows for better polishability and ability to maintain luster and gloss over time.¹

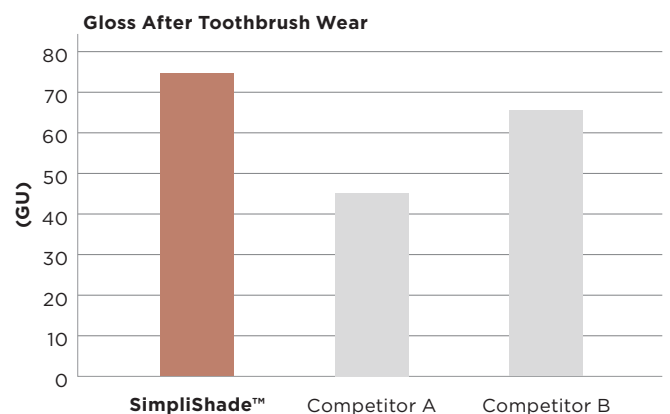
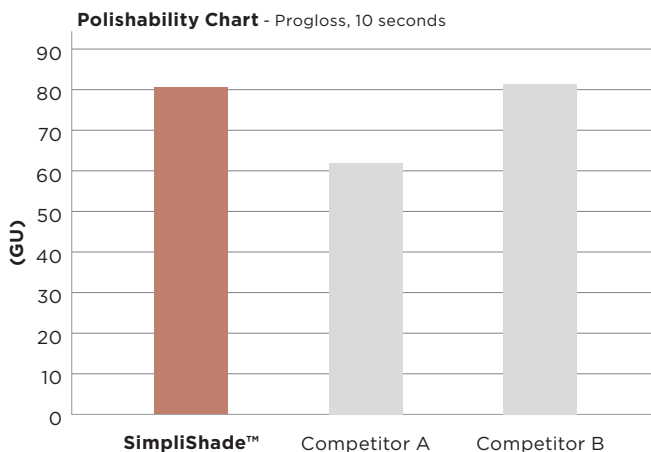

1. Data available on request

Longer-lasting Restorations

ART system allows for high loading of 81% for excellent strength, better resistance to chipping and fracture overtime.

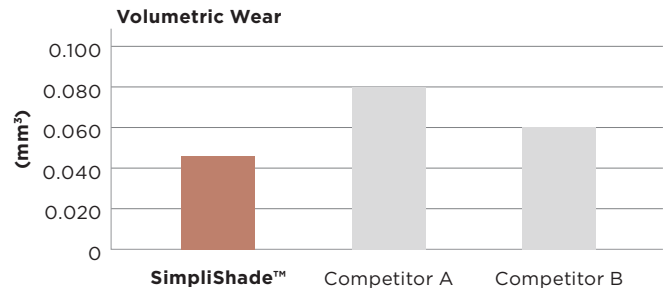
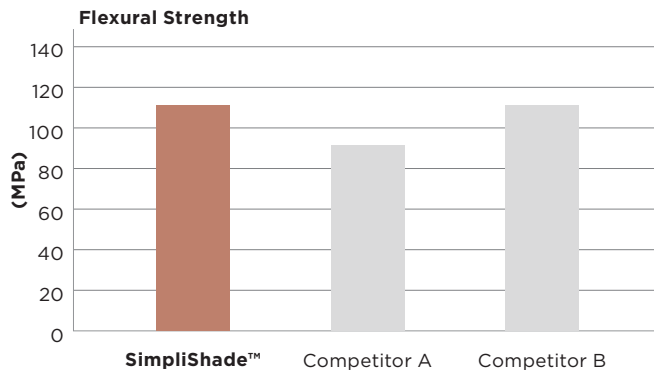

Excellent Radiopacity

The more radiopaque, the easier it is to distinguish the restoration from the tooth structure under a radiograph. SimpliShade at 300% AI is almost twice as radiopaque as competition.¹



Optimal Translucency

SimpliShade provides ideal opacity to mimic tooth structure, to better mask underlying tooth stains, and blend well with surrounding dentition, resulting in a more lifelike restoration.¹

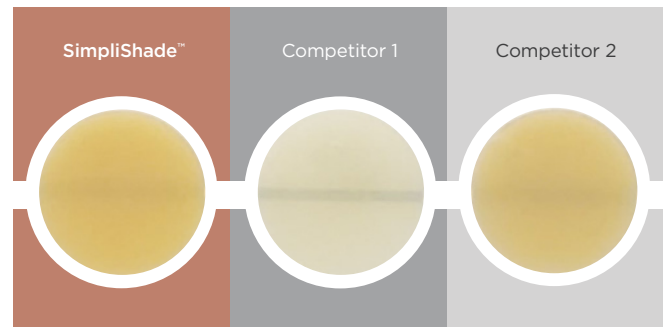

SimpliShade™	REF/Part No.
SimpliShade – 4g Syringe – Light	37001
SimpliShade – 4g Syringe – Medium	37002
SimpliShade – 4g Syringe – Dark	37003
SimpliShade – 4g Syringe – Bleach White	37004
SimpliShade – 4g Syringe – Universal Opaque	37005
SimpliShade – 20x 0.25g Unidose – Light	37006
SimpliShade – 20x 0.25g Unidose – Medium	37007
SimpliShade – 10x 0.25g Unidose – Dark	37008
SimpliShade – 10x 0.25g Unidose – Bleach White	37009
SimpliShade – 10x 0.25g Unidose – Universal Opaque	37010

Harmonize™

Universal composite with Adaptive Response Technology

Harmonize™ begins with ART, Adaptive Response Technology, the nanoparticle filler system that makes achieving lifelike restorations easier than ever before. It is formed of 81% inorganic material by weight, with an average primary particle size of less than 50 nm.

It is the ART in Harmonize that enables:

- Adaptive reflection to the light wavelength for an enhanced chameleon effect
- Superior gloss retention and easier polishability
- Adaptive viscosity for an easy shape of the composite and prevention of slumping
- Minimised stickiness and simplified carving
- Better curing efficacy for a long-lasting performance.



Light reflection like a natural tooth

Just like a natural human tooth, and unlike other universal composites, Harmonize adapts to the light wavelength by reflecting diffuse light at lower wavelengths and specular light at higher wavelengths. This results in better blending than leading composites.¹

Lower wavelengths
- Blue colour -

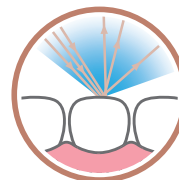

Diffuse reflection

Higher wavelengths
- Red colour -

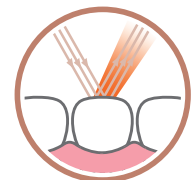

Specular reflection

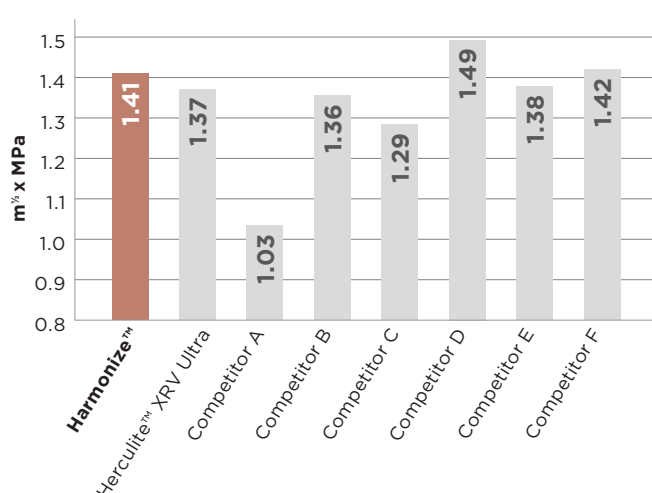

Proven mechanical strength

Harmonize demonstrates superior strength to other composites.

¹. Data available on request

Spherical shape

The spherical shape of the ART filler system is carefully controlled to maximise loading, minimising stickiness and simplifying carving. This reduces the risk of pullback and cavosurface voids.

Competition

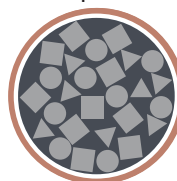

Harmonize

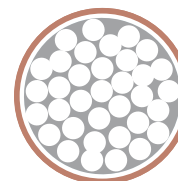

Harmonize™ — Syringe Intro Kit REF/Part No. 36633

4x 4g Syringe (1x Dentine A3, 1x Dentine A3.5, 1x Enamel A2, 1x Enamel A3),
Instructions for Use

Harmonize™ — Unidose Intro Kit REF/Part No. 36634

40x 0.25g Unidose (10x Dentine A3, 10x Dentine A3.5, 10x Enamel A2, 10x Enamel A3),
Instructions for Use

Harmonize™ — Syringe Advanced Kit REF/Part No. 36635

8x 4g Syringe (1x Dentine A2, 1x Dentine A3, 1x Dentine A4, 1x Enamel A2, 1x Enamel A3,
1x Incisal Amber, 1x Incisal Clear, 1x Incisal Grey), Instructions for Use

Harmonize™ — Refills

Shade	1x 4g Syringe	20x 0.25g Unidose
Harmonize — Dentine A1	36545	36571
Harmonize — Dentine A2	36536	36572
Harmonize — Dentine A3	36546	36573
Harmonize — Dentine A3.5	36547	36574
Harmonize — Dentine A4	36548	36575
Harmonize — Dentine B3	36549	36576
Harmonize — Dentine C4	36550	36577
Harmonize — Dentine XL2	36551	36578
Harmonize — Enamel A1	36552	36579
Harmonize — Enamel A2	36537	36542
Harmonize — Enamel A3	36553	36581
Harmonize — Enamel A3.5	36554	36582
Harmonize — Enamel A4	36555	36583
Harmonize — Enamel B1	36556	36584
Harmonize — Enamel B2	36557	36585
Harmonize — Enamel B3	36558	36586
Harmonize — Enamel B4	36559	36587
Harmonize — Enamel C1	36560	36588
Harmonize — Enamel C2	36561	36589
Harmonize — Enamel C3	36562	36590
Harmonize — Enamel C4	36563	36591
Harmonize — Enamel D2	36564	36592
Harmonize — Enamel D3	36565	36593
Harmonize — Enamel D4	36566	36594
Harmonize — Enamel XL	36567	36595
Harmonize — Incisal Translucent Amber	36538	36543
Harmonize — Incisal Translucent Blue	36568	36597
Harmonize — Incisal Translucent Clear	36569	36598
Harmonize — Incisal Translucent Grey	36570	36599
Harmonize — Incisal Translucent SuperClear	36539*	

* 3g Syringe

Harmonize™ — Universal Shade Guide REF/Part No. 36883

Universal Shade Guide



Harmonize™ — Syringe Intro Kit



Harmonize™ — Unidose Intro Kit



Harmonize™ — Syringe Advanced Kit



Harmonize™ — Universal Shade Guide

Herculite™ XRV Ultra™

Universal nanohybrid dental composite

Based on the well-established Herculite XRV formula, Herculite™ XRV Ultra™ uses nano-filler technology to bring more comfortable handling, polishability and wear resistance. It also replicates the opalescence and fluorescence of the natural tooth to give a more aesthetic appearance.



Herculite™ XRV Ultra™ — Standard Kit Syringe REF/Part No. 33856

10 Syringes (4g) in shades: Enamel A1, A2, A3, A3.5, B2, B3, C2, D2 Dentine A2, A3, Accessories*

Herculite™ XRV Ultra™ — Standard Kit Unidose REF/Part No. 33857

10 Unidoses (10x0.2g) in shades: Enamel A1, A2, A3, A3.5, B2, B3, C2, D2 Dentine A2, A3, Accessories*

Herculite™ XRV Ultra™ — Intro Kit Syringe REF/Part No. 33858

6 Syringes (4g) in shades: Enamel A1, A2, A3, A3.5, D2 — Dentine A2, Accessories*

Herculite™ XRV Ultra™ — Intro Kit Unidose REF/Part No. 33859

Contents: 6 Unidoses® (10x0.2g) in shades: Enamel A1, A2, A3, A3.5, D2 Dentine A2, Accessories*

* 1 Premise Flowable A2 composite (1.7g), 10 Tips for flowable composite, 1 OptiBond™ Solo Plus™ Bottle (5ml), 1 Gel Etchant (3g), 1 OptiDisc™ Sample Kit with 15 pcs of Extra-coarse, Coarse/Medium, Fine and Extra-fine OptiDiscs size 12.6 mm and 2 mandrels, 25 Mixing Wells, 50 Applicator Tips, 10 Gel Etchant Syringe Tips

Herculite™ XRV Ultra™ — Mini Kit Syringe with OptiBond Solo Plus REF/Part No. 33860

3 Syringes (4g): Enamel A2, A3 and Dentine A2, 1 OptiBond Solo Plus Bottle (5ml), 1 Gel Etchant (3g), 25 Mixing Wells, 50 Applicator Tips

Herculite™ XRV Ultra™ — Mini Kit Unidose with OptiBond Solo Plus REF/Part No. 34071

3 Unidoses (10x0.2g): Enamel A2, A3 and Dentine A2, 1 OptiBond Solo Plus Bottle (5ml), 1 Gel Etchant (3g), 25 Mixing Wells, 50 Applicator Tips

Herculite™ XRV Ultra™ — Refills

Shade	1x 4g Syringe	20x 0.2g Unidose
Herculite XRV Ultra — Enamel XL	34001	34028
Herculite XRV Ultra — Enamel A1	34002	34029
Herculite XRV Ultra — Enamel A2	34003	34030
Herculite XRV Ultra — Enamel A3	34004	34031
Herculite XRV Ultra — Enamel A3.5	34005	34032
Herculite XRV Ultra — Enamel A4	34006	34033
Herculite XRV Ultra — Enamel B1	34007	34034



Herculite™ XRV Ultra™ — Standard Kit Syringe



Herculite™ XRV Ultra™ — Intro Kit Syringe



Herculite™ XRV Ultra™ — Mini Kit Syringe

Herculite™ XRV Ultra™ — Refills

Shade	1 x 4 g Syringe	20 x 0.2g Unidose
Herculite XRV Ultra — Enamel B2	34008	34035
Herculite XRV Ultra — Enamel B3	34009	34036
Herculite XRV Ultra — Enamel B4	34010	34037
Herculite XRV Ultra — Enamel C1	34011	34038
Herculite XRV Ultra — Enamel C2	34012	34039
Herculite XRV Ultra — Enamel C3	34013	34040
Herculite XRV Ultra — Enamel C4	34014	34041
Herculite XRV Ultra — Enamel D2	34015	34042
Herculite XRV Ultra — Enamel D3	34016	34043
Herculite XRV Ultra — Enamel D4	34017	34044
Herculite XRV Ultra — Incisal — Neutral	34027	34054
Herculite XRV Ultra — Dentine A1	34018	34045
Herculite XRV Ultra — Dentine A2	34019	34046
Herculite XRV Ultra — Dentine A3	34020	34047
Herculite XRV Ultra — Dentine A3	34021	34048
Herculite XRV Ultra — Dentine B1	34022	34049
Herculite XRV Ultra — Dentine B2	34023	34050
Herculite XRV Ultra — Dentine C2	34024	34051
Herculite XRV Ultra — Dentine D2	34025	34052
Herculite XRV Ultra — Dentine D3	34026	34053
Herculite XRV Ultra — Medium Incisal	35371	35370

Herculite™ XRV

Universal microhybrid composite

Herculite™ XRV has been the industry standard for dental composites for 20 years. Based on micro-filled technology, it is proven to bring long-term durability to restorations. It is formed of 79% inorganic material (by weight), with an average particle size of 0.6 µm.



Herculite™ XRV – General Kit



Herculite™ XRV — aesthetic Kit with OptiBond Solo Plus REF/Part No. 30893

1x 5g Syringe of each shade: Enamel — A1, A2, A3, A3.5, A4, B1, B2, B3, B4, C1, C2, C3, C4, D2, D3, D4. Dentine — A2, A3, A3.5, B1, B2, C2, D2. 1x 2.5g Syringe of each shade: Incisal Medium and Incisal Light, 5ml Bottle OptiBond Solo Plus, 50 Disposable Applicator Tips, 25 Disposable Mixing Wells, 1x 3g Gel Etchant Syringe with 10 Disposable Tips

Herculite™ XRV — General Kit with OptiBond Solo Plus REF/Part No. 30894

1x 5g Syringe of each shade: Enamel — A1, A2, A3, A3.5, B1, B3, C2, C3, D2, D3. Dentine — A2, B1, C2, D2. 1x 2.5g Syringe of each shade: Incisal Medium and Incisal Light, 5ml Bottle OptiBond Solo Plus, 50 Disposable Applicator Tips, 25 Disposable Mixing Wells, 1x 3g Gel Etchant Syringe with 10 Disposable Tips

Herculite™ XRV — Unidose Kit with OptiBond Solo Plus REF/Part No. 30895

10x 0.25g Unidose Tips of each shade: Enamel — A1, A2, A3, A3.5, B1, B3, C2, C3, D2, D3. Dentine — A2, B1, C2, D2. Incisal Medium and Incisal Light. 5ml Bottle OptiBond Solo Plus, 50 Disposable Applicator Tips, 25 Disposable Mixing Wells, 1x 3g Gel Etchant Syringe with 10 Disposable Tips

Herculite™ XRV — Refills

Shade	1x 4g Syringe	20x 0.2g Unidose
Herculite XRV — Enamel A1	22859	23036
Herculite XRV — Enamel A2	22860	23037
Herculite XRV — Enamel A3	22861	23038
Herculite XRV — Enamel A3.5	22862	23039
Herculite XRV — Enamel A4	22863	23040
Herculite XRV — Enamel B1	22864	23041
Herculite XRV — Enamel B2	22865	23042
Herculite XRV — Enamel B3	22866	23043
Herculite XRV — Enamel B4	22867	23044
Herculite XRV — Enamel C1	22868	23045
Herculite XRV — Enamel C2	22869	23046
Herculite XRV — Enamel C3	22870	23047
Herculite XRV — Enamel C4	22871	23048
Herculite XRV — Enamel D2	22872	23049
Herculite XRV — Enamel D3	22873	23050
Herculite XRV — Enamel D4	22874	23051
Herculite XRV — Dentine A1	23391	-
Herculite XRV — Dentine A2	22875	23052
Herculite XRV — Dentine A3	22876	23053
Herculite XRV — Dentine A3.5	22877	23054

Herculite™ XRV — Refills

Shade	1x 4 g Syringe	20x 0.2g Unidose
Herculite XRV — Dentine A4	23390	-
Herculite XRV — Dentine B1	22878	23055
Herculite XRV — Dentine B2	22879	23056
Herculite XRV — Dentine B3	23389	-
Herculite XRV — Dentine B4	23388	-
Herculite XRV — Dentine C1	23387	-
Herculite XRV — Dentine C2	22880	23057
Herculite XRV — Dentine C3	23386	-
Herculite XRV — Dentine C4	23385	-
Herculite XRV — Dentine D2	22881	23058
Herculite XRV — Dentine D3	23384	-
Herculite XRV — Dentine D4	23392	-
Herculite XRV — Cervical Red/Brown	29832	-
Herculite XRV — Cervical Yellow/Brown	29834	-
Herculite XRV — Incisal Light	22882*	23059
Herculite XRV — Incisal medium	22883*	23060

* 2.5 g Syringe

Premise™

Trimodal nanohybrid composite

Premise™ has a trimodal filler system which uses three distinct filler sizes to increase loading. In addition, the incorporation of PPF (pre-polymerised filler) limits shrinkage and enhances polishability and wear resistance. Premise also builds on the proven success of Point4 by using the same 0.4µm barium glass filler.



Premise™ — Standard Kit

Premise™ — Syringe Standard Kit

REF/Part No. 35457

1x 4g Syringe of each shade: Enamel A2, A3, A3.5, B2, Dentine A2, A3, A3.5, Translucent Clear, OptiBond XTR Primer 5ml, OptiBond XTR Adhesive 5ml, 50 Applicator Tips, Kerr Polishing Kit*

Premise™ — Unidose Standard Kit

REF/Part No. 35458

10x 0.2g Unidose Tips of each shade: Enamel A2, A3, A3.5, B2, Dentine A2, A3, A3.5, Translucent Clear, OptiBond XTR Primer 5ml, OptiBond XTR Adhesive 5ml, 50 Applicator Tips, KerrHawe Polishing Kit*

* 15x 12.6mm OptiDisc - 5 of each Coarse/Medium, Fine and Extra-fine, 2 OptiDisc mandrels, 4x GlossPLUS Polishers - 2 of each Flame and Cup, 4x HiLusterPLUS Dia Polishers - 2 of each Flame and Cup.

Premise™ — Syringe Mini Kit

REF/Part No. 35372

1x 4g Syringe of each shade: Enamel A2, A3, Dentine A3, OptiBond Solo Plus 5ml, 50 Applicator Tips.

Premise™ — Refills

Shade	1x 4 g Syringe	20x 0.2g Unidose
Premise — Enamel A1	32712	32745
Premise — Enamel A2	32713	32746
Premise — Enamel A3	32714	32747
Premise — Enamel A3.5	32715	32748
Premise — Enamel A4	32716	32749
Premise — Enamel B1	32717	32750

Premise™ — Refills

Shade	1x 4 g Syringe	20x 0.2g Unidose
Premise — Enamel B2	32718	32751
Premise — Enamel B3	32719	32752
Premise — Enamel B4	-	32753
Premise — Enamel C1	32721	32754
Premise — Enamel C2	32722	-
Premise — Enamel C3	32723	32756
Premise — Enamel C3	32723	32756
Premise — Enamel C4	-	32757
Premise — Enamel D2	32725	-
Premise — Enamel D3	32726	32759
Premise — Enamel D4	32727	32760
Premise — Enamel XL1	32728	-
Premise — Enamel XL2	32729	-
Premise — Dentine A2	32730	32763
Premise — Dentine A3	32731	32764
Premise — Dentine A3.5	32732	32765
Premise — Dentine A4	32733	32766
Premise — Dentine B1	32734	32767
Premise — Dentine B2	-	32768
Premise — Dentine D2	32737	32770
Premise — Translucent Amber	32738	-
Premise — Translucent Grey	-	32772
Premise — Translucent Clear	32740	32773
Premise — Translucent SuperClear	32741	32774

Point4™

Optimised particle composite system

When first introduced to the market, Point4™ represented years of research aimed at bridging the gap between micro-filled and hybrid composite materials. It is an optimised particle composite system made of 76% inorganic filler (by weight), with an average particle size of 0.4 µm. Suitable for anterior and posterior restorations, it is available in 16 Vita shades.



Point4™

Point4™ — Intro Kit

REF/Part No. 29687

1x 4g Syringe of each shade: A2, A3, A3.5, B2, T1, 1x 5ml Bottle OptiBond Solo Plus, 2x 3g Syringes Gel Etchant, 20 Disposable Gel Etchant Syringe Tips, 25 Disposable Mixing Wells, 50 Disposable Applicator Tips

Point4™ — Refills

Shade	1x 4g Syringe	20x 0.2g Unidose
Point4 — A1	29876	29898
Point4 — A2	29877	29899
Point4 — A3	29878	29900
Point4 — A3.5	29879	29901
Point4 — A4	29880	29902
Point4 — B1	29881	29903
Point4 — B2	29882	29904
Point4 — B3	29883	29905
Point4 — B4	29884	29906
Point4 — C1	29885	29907
Point4 — C2	29886	29908
Point4 — C3	29887	29909
Point4 — C4	29888	29910
Point4 — D2	29889	29911
Point4 — D3	29890	29912
Point4 — D4	29891	29913
Point4 — XL1	29892	29914
Point4 — XL2	29893	29915
Point4 — Translucent T1	29895	29917
Point4 — Translucent T2	29896	-
Point4 — Translucent T3	29897	-
Point4 — Opaque A2	31360	31368
Point4 — Opaque A3	31361	31369
Point4 — Opaque A3.5	31362	31370
Point4 — Opaque B1	31364	-
Point4 — Opaque B2	31365	-

3.5 Composites — Bulk-fill

SonicFill™ 3

Single-Fill™ Bulk-fill dental composite system

SonicFill™ 3 is the unique bulk-fill composite system powered by sonic energy, expertly blending KaVo technology and Kerr material knowledge into one system. A patented rheological modifier reacts to sonic energy:

- **Sonic energy applied:**
viscosity drops for quick and precise placement
- **Sonic energy interrupted:**
viscous non-slumping state for great carving

SonicFill 3 does not require liner nor capping layer, and its unique features in terms of adaptation and depth of cure of up to 5 mm make it ideal for all larger cavity restorations. The lower shrinkage stress than other bulk-fill or conventional composites ensures marginal integrity and reduces post-operative sensitivity.

All this makes it possible to achieve a successful restoration in a simple single step.



Proven outcomes. A step up from the rest

- **Shrinkage Stress**

SonicFill™ 3 has a lower shrinkage stress than competitors.*

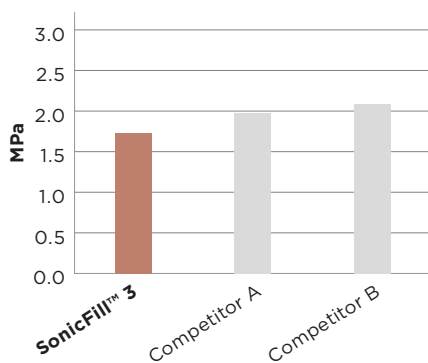

- **Flexural Strength**

SonicFill™ 3 has a higher flexural strength than competitors.*

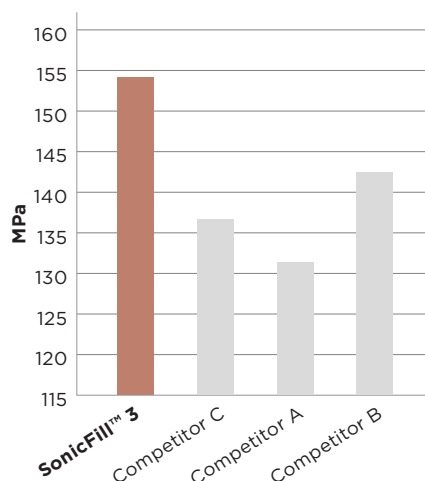

- **Degree of Conversion**

At 5mm, SonicFill™ 3 showed 86.6% hardness at the bottom when compared to the top.*

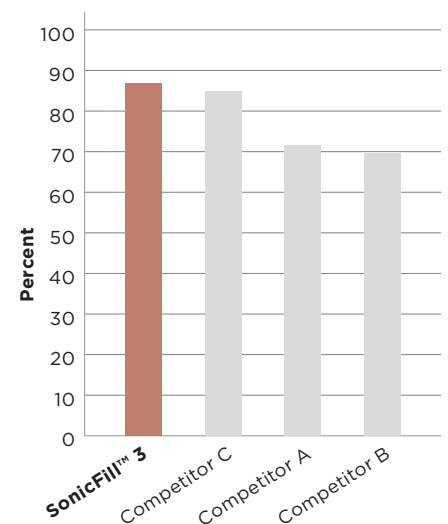

* Shrinkage Stress at 2 minutes

Activation - Efficient Liquefaction

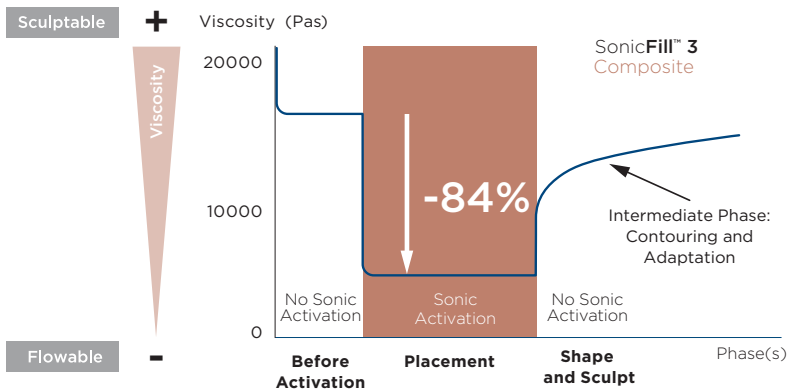

1. Data available on request

Unique, patented technology

SonicFill's secret lays in its highly-filled proprietary resin with special modifiers that react to sonic energy applied through the handpiece. When sonic energy is applied the viscosity drops (up to 84%), enabling quick placement and precise adaptation to the cavity walls. When the sonic energy is stopped, the composite returns to a more viscous, non-slumping state that is perfect for carving and contouring.

The fewer steps, the less chance of misstep

SonicFill™ 3 replaces conventional time-consuming, multi-stage layering techniques with a SingleFill™ Composite System that eliminates the need for placing a liner or final capping layer.

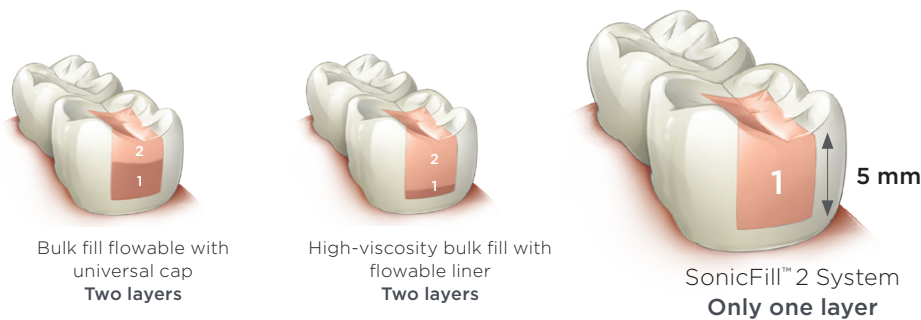

SonicFill™ 3 – Intro Kit REF/Part No. 36715

1x SonicFill Handpiece + Instructions for Use, 1x Getting Started Pack (5 Unidose Tips and 5 Tooth Models), 10x 0.2g SonicFill 3 Unidose A1 Composite, 20x 0.2g SonicFill 3 Unidose A2 Composite, 30x 0.25g SonicFill 3 Unidose A3 Composite, Instructions for Use, Technique Guide

SonicFill™ 3 – Unidose Tips – 20 x 0.25g REF/Part No.

SonicFill 3 – Unidose Composite Refill A1	36711
SonicFill 3 – Unidose Composite Refill A2	36712
SonicFill 3 – Unidose Composite Refill A3	36713
SonicFill 3 – Unidose Composite Refill B1	36714

SonicFill™ – Handpiece REF/Part No. 1.007.7400

SonicFill Handpiece to activate SonicFill Unidose Tips. (Adjustable with 5 power settings)

SonicFill™ – Multiflex Couplings REF/Part No.

SonicFill – Multiflex Coupling 465LED	1.007.3197
SonicFill – Multiflex Coupling 457	0.553.1210
SonicFill – Multiflex Coupling 454N	0.553.1620



SonicFill™ 3 – Intro Kit



SonicFill™ 3 – Unidose Composite Refill

3.5 Composites — Flowable

Vertise™ Flow

Self-adhering flowable composite

Vertise™ Flow is the first self-adhering flowable dental composite powered by OptiBond™ technology. It greatly simplifies direct restorative procedures by incorporating a bonding agent into a flowable, reducing steps and saving time.

Vertise™ — Test-Me Kit REF/Part No. 34398

1x 2g Syringe A2 shade, 10 Application Brushes, 10 Tips

Vertise™ — Assorted Kit REF/Part No. 34399

4x 2g Syringe in A2, A3, A3.5, UO, 40 Application Brushes, 40 Tips

Vertise™ — Paedodontic Kit REF/Part No. 34400

4x 2g Syringe in shades A1, B1, XL, Translucent, 40 Application Brushes, 40 Tips

Vertise™ — Refills REF/Part No.

2x 2g Syringes, 20 Application Brushes, 20 Tips

Vertise — A1	34401
Vertise — A2	34402
Vertise — A3	34403
Vertise — A3.5	34404
Vertise — B1	34405
Vertise — B2	34406
Vertise — Universal Opaque	34407
Vertise — XL	34408
Vertise — Translucent	34409

Vertise™ — Brushes and Tips Refill REF/Part No. 34410

25x Application Brushes and Tips



Vertise™ — Test-Me Kit



Vertise™ — Assorted Kit



Vertise™ — Refills

Herculite™ XRV Ultra Flow

Nanohybrid flowable composite

Herculite™ XRV Ultra Flow combines the long-standing expertise of the Herculite brand in an innovative flowable composite. The Smart Placement Technology offered by a rheological additive helps reduce surface tension as the material contacts the tooth surface under pressure – allowing it to flow to the boundaries of the restoration. The same additive encourages higher surface tension after the material has been placed. The formula also guarantees flexural strength as well as excellent gloss retention and easy polishability.



Herculite™ XRV Ultra Flow



A flowable with the performance you need

Outstanding flexural strength

Similar to its companion Herculite XRV Ultra, Herculite XRV Ultra Flow has excellent mechanical properties, including strength.

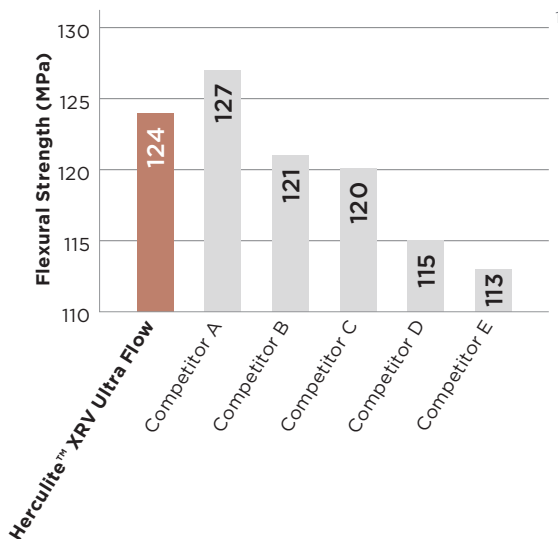

Low shrinkage

Leading experts cite low shrinkage as a critical feature of flowable composites; Herculite XRV Ultra Flow was specially designed with a high-filler loading rate for minimal polymerisation shrinkage.

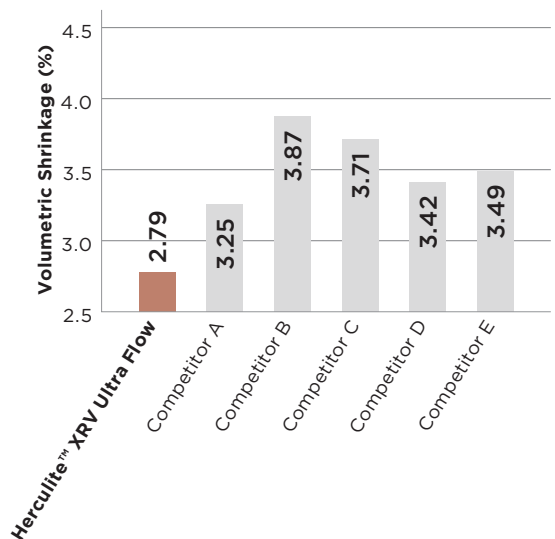

Herculite™ XRV Ultra Flow — Refill Syringes	REF/Part No.
Herculite XRV Ultra Flow — A2	35408
Herculite XRV Ultra Flow — A3	35409
Herculite XRV Ultra Flow — A3.5	35410
Herculite XRV Ultra Flow — A4	35411
Herculite XRV Ultra Flow — B1	35412
Herculite XRV Ultra Flow — B2	35413
Herculite XRV Ultra Flow — C2	35414

Herculite™ XRV Ultra Flow — Refill Syringes	REF/Part No.
Herculite XRV Ultra Flow — D2	35415
Herculite XRV Ultra Flow — XL1	35416
Herculite XRV Ultra Flow — XL2	35417
Herculite XRV Ultra Flow — Universal Opaque	35418

Herculite™ XRV Ultra Flow - Dispensing Tips	REF/Part No. 33370
50 x Dispensing Tips	

1. Data available on request

Revolution™ Formula 2

Flowable light cure composite

Revolution™ Formula 2 is a flowable light-cured, hybrid composite for Class III, IV and V restorations that is 60% filled (by weight) with an average particle size of 0.6µm. It flows into the preparation for easier placement and contouring, which is ideal where minimally invasive techniques are indicated. Revolution Formula 2 is fast and easy-to-use, providing excellent colour stability and polishing to achieve a high-quality aesthetic finish.



Revolution™ Formula 2 — Refill

Revolution™ Formula 2 — Intro Kit **REF/Part No. 29514**

4 x 1g Syringe of each shade: A2, B3, C3 and Universal Opaque, 20 Tips

Revolution™ Formula 2 — Assorted Kit **REF/Part No. 29515**

3 x 1g Syringe of each shade: 1 Incisal, 1 Gingival and 1 White Opaque, 20 Tips

Revolution™ Formula 2 — Refills **REF/Part No.**

4 x 1g Syringes, 20 Tips

Revolution Formula 2 — A1	29493
Revolution Formula 2 — A2	29494
Revolution Formula 2 — A3	29495
Revolution Formula 2 — A3.5	29496
Revolution Formula 2 — A4	29497
Revolution Formula 2 — B1	29498
Revolution Formula 2 — B2	29499
Revolution Formula 2 — B3	29500
Revolution Formula 2 — C1	29502
Revolution Formula 2 — C2	29503
Revolution Formula 2 — C3	29504
Revolution Formula 2 — C4	29505
Revolution Formula 2 — D2	29506
Revolution Formula 2 — D3	29507
Revolution Formula 2 — XL	29509
Revolution Formula 2 — Gingival	29510
Revolution Formula 2 — Universal Opaque	29512
Revolution Formula 2 — White Opaque	29513

Revolution™ Formula 2 — Tips Refills **REF/Part No.**

100 Dispensing Tips Black— 22 gauge	450119
100 Dispensing Tips Yellow— 20 gauge	450120

Premise™ Flowable

Flowable light cure composite

Premise™ Flowable is a medium viscosity, light-cured composite suitable for numerous direct applications. Pre-polymerised filler, nano-filler and proven Point4 technology are combined to deliver strength and durability.



Premise™ Flowable



Premise™ Flowable — Assorted Kit REF/Part No. 33371

1x 1.7g Syringe of each shade: A1, A2, A3, B1, 40 Tips

Premise™ Flowable — Refills REF/Part No.

	40 x 1.7g Tips	1 x 1.7g Syringes + 10 Tips
Premise Flowable — A1	33372	33721
Premise Flowable — A2	33373	33722
Premise Flowable — A3	33374	33723
Premise Flowable — A3.5	33375	33724
Premise Flowable — B1	33376	33725
Premise Flowable — B2	33385	33726
Premise Flowable — XL	33380	33730
Premise Flowable — Universal Opaque	33378	33728

Premise™ Flowable — Tips Refills REF/Part No. 33370

Premise Flowable — 50 Tips

3.6 Permanent cements and liners

Maxcem Elite™

Self-etch, self-adhesive resin cement

Maxcem Elite™ self-etch, self-adhesive resin cement for indirect restorations is simplicity refined, offering best-in-class adhesion when compared to other leading self-adhesive cements. Its thixotropic property facilitates the placement of material and clean-up.

- One-Peel™ clean-up, no hand mixing and no refrigeration required
- Dual-cure mechanism
- No colour shift
- Compatible with all indirect restorations

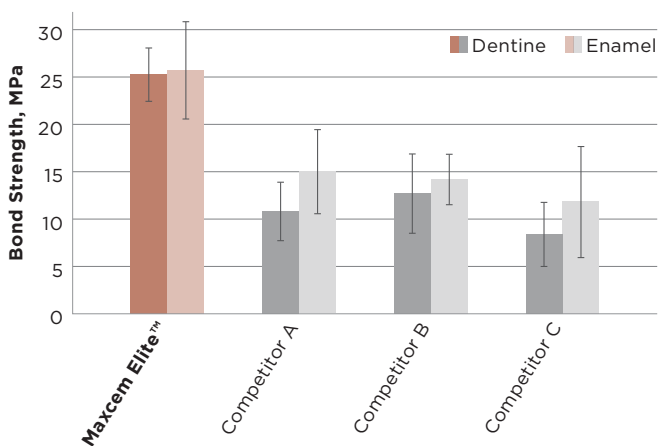

Bond strength to enamel and dentine

Maxcem Elite™ employs the same unique adhesive monomer used in Kerr's OptiBond family of bonding agents. The optimized resin matrix and filler systems improve wettability, resulting in greater adhesion to dentine.

No colour shift for better aesthetics

The colour change in Maxcem Elite is imperceptible, when compared to systems that contain tertiary amines.

Colour shift over time is better than leading self-adhesive or adhesive resin cements.

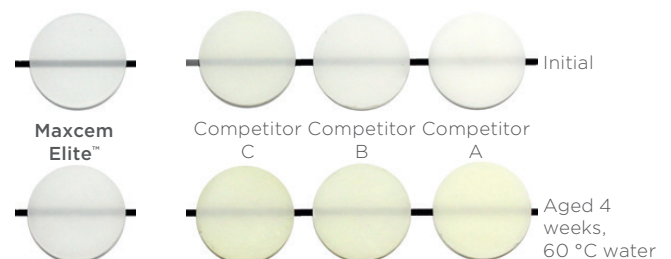

1. Data available on request



One-Peel™ clean-up for consistent outcomes

Maxcem Elite's thixotropic property facilitates the placement of material and easy clean-up.

Now Featuring Universal Flexibility

Maxcem Elite™ delivers high bond strength when used on its own. For restorations that require even higher bond strength, just pair Maxcem with a universal bonding agent like OptiBond™ Universal.

Maxcem Elite™ — Standard Kit REF/Part No. 34055

5x 5g Syringes (2x clear, 1x white, 1x white opaque, 1x Yellow), 24x Automix Tips (regular), 16x Automix Tips (wide opening), 8x Intraoral Tips, 8x Root Canal Tips, Technique Guide

Maxcem Elite™ — Value Kit REF/Part No. 34056

2x 5g Syringes (clear), 1x 11.7g Temp-Bond NE automix Syringe, 8x Automix Tips (regular), 8x Automix Tips (wide opening), 8x Intraoral Tips, 8x Temp-Bond Automix Tips, Technique Guide

Maxcem Elite™ — Mini Kit REF/Part No. 34057

1x 5g Syringe (clear), 5x Automix Tips (regular), 4x Automix Tips (wide opening), 4x Intraoral Tips, Technique Guide

Maxcem Elite™ — Refills REF/Part No.

2x 5g Syringe, 8x Automix Tips regular, 8x Automix Tips with wide opening, 8x Intraoral Tips, Technique Guide

Maxcem Elite — Clear	34058
Maxcem Elite — White	34059
Maxcem Elite — White Opaque	34060
Maxcem Elite — Yellow	34061

Maxcem Elite™ — Accessories REF/Part No.

Maxcem Elite — 40x Mixing Tips (Regular)	34074
Maxcem Elite — 8x Intraoral Tips — Automix Tips (Wide)	34075
Maxcem Elite — 8x Root Canal Tips — Automix Tips (Wide)	34076



Maxcem Elite™ — Standard Kit



Maxcem Elite™ — Value Kit



Maxcem Elite™ — Mini Kit



Maxcem Elite™ — Refills

Maxcem Elite™ Chroma

Self-etch, self-adhesive resin cement with clean-up indicator

Maxcem Elite™ Chroma self-etch, self-adhesive resin cement for indirect restorations is the evolution of Maxcem Elite™. With the same formula, same bond strength, same performance with a unique feature: a gel state colour clean-up indicator that shows dentists the ideal time to remove excess cement.

It is suitable for use with all desired indirect restorations and substrates including zirconia, gold, rexillium, lithium disilicate, porcelain, composite and titanium.

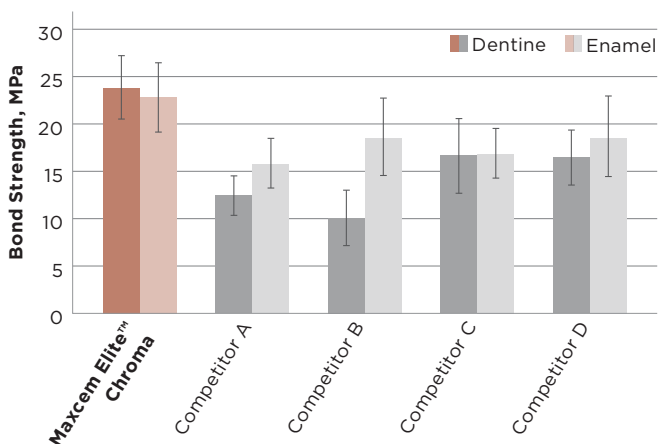

High bond strength

- Reliable and predictable
- Best-in-class adhesion compared to other leading self-adhesive cements
- 90% higher bond strength on dentine
- 65% higher bond strength on enamel
- Forms a strong and durable bond with various dental substrates

280% radiopacity

Outstanding radiopacity allows easy detection on a radiograph.

Easy storage

No need to refrigerate.

Dual cure

Pink disappears after both self-cure and light cure, allowing maximum flexibility.

One-peel™ clean-up

Cement is easy-to-remove in one peel, reducing the risk of leaving excess cement.

Automix delivery system

- Dual barrel, automix syringe system
- Comes with single-use automix tips
- Optional curved tips deliver desired amount of cement into restoration and/or tooth prep

Long-term colour stability

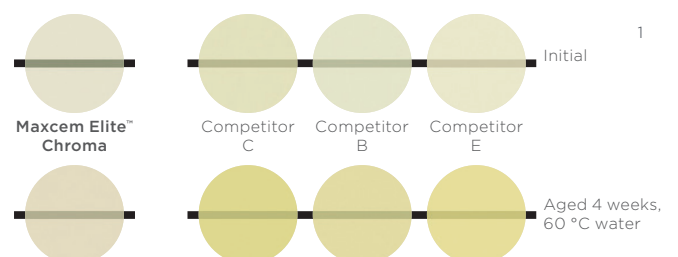

1. Data available on request

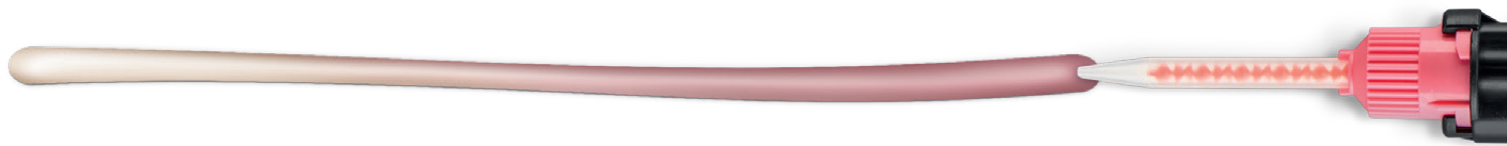

Use with desired substrates

- Zirconia
- Gold
- Rexillium
- Lithium disilicate
- Porcelain
- Composite

Colour clean-up indicator

Cement is pink when dispensed and gradually fades to the cement shade, indicating the optimal window of time to clean up excess cement.

Now Featuring Universal Flexibility

Maxcem Elite™ delivers high bond strength when used on its own. For restorations that require even higher bond strength, just pair Maxcem with a universal bonding agent like OptiBond™ Universal

Maxcem Elite™ Chroma — Standard Kit

REF/Part No. 36371

4 x 5g Syringes (2x Clear, 1x White, 1x Yellow), 16x Automix Tips (Regular), 8x Automix Tips (Wide), 8x Intraoral Tips, 8x Root Canal Tips, Technique Guide

Maxcem Elite™ Chroma — Refills

REF/Part No.

2x 5g Syringe, 8x Automix Tips regular, 8x Automix Tips with wide opening, 8x Intraoral Tips, Technique Guide

Maxcem Elite Chroma — Clear

36372

Maxcem Elite Chroma — White

36373

Maxcem Elite Chroma — Yellow

36374

Maxcem Elite™ Chroma — Accessories

REF/Part No.

Maxcem Elite Chroma — 40x Mixing Tips (Regular)

36375

Maxcem Elite Chroma — 8x Root Canal Tips — Automix Tips (Wide)

36376

Maxcem Elite Chroma — 8x Intraoral Tips — Automix Tips (Wide)

36377



Maxcem Elite™ Chroma — Standard Kit



Maxcem Elite™ Chroma — Refills



Maxcem Elite™ Chroma — 40x Mixing Tips

Nexus™ Universal

A Truly Universal Adhesive Resin Cement

Nexus™ Universal eliminates the need for primers or activators — cutting the complexity of typical cementation processes by up to 50%. With simplicity comes added flexibility and convenience. Nexus Universal adapts to your preferred cementation technique, so you don't have to change your protocol. It also pairs with leading universal bonding agents including OptiBond™ Universal, part of the OptiBond™ family of products widely recognized as the gold standard.



Simplified workflow

Nexus Universal cuts the complexity of typical cementation processes by up to 50%. Simple Dark Cure Technique with any OptiBond adhesive or any other leading universal bonding agent.

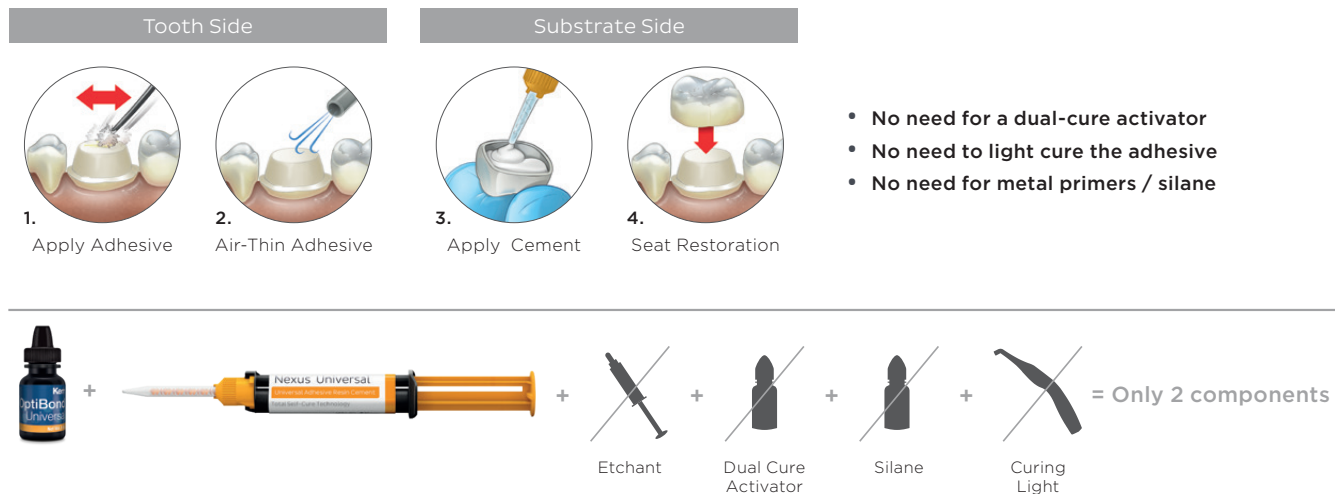

A simplified, faster, and more efficient workflow means less opportunities for error.

Boost your bond strength

Nexus Universal and OptiBond Universal deliver stronger bonds than other leading cementation systems in dark-cure mode.

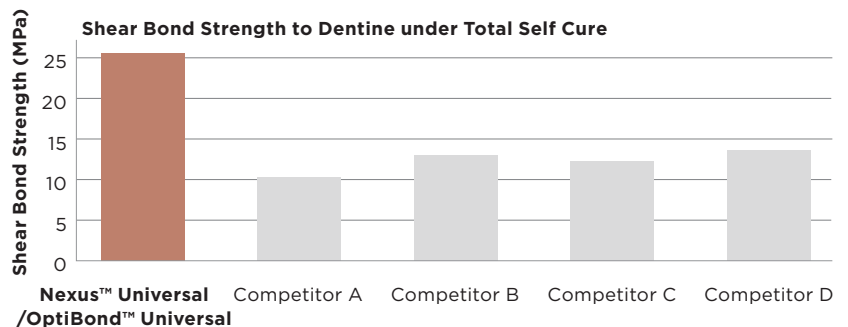

Nexus Universal Chroma color cleanup indicator

Cement is pink when dispensed and gradually fades to the cement shade. Tack-cure or self-cure for more control over single or multiple crowns. Cleanup is simple once the pink color has turned to the cement color, indicating the optimal window of time to cleanup excess cement - reducing the risk of leaving excess cement.



High performance on any substrate

Nexus Universal is compatible with various indirect restorations and CAD/CAM materials, including resin, ceramic, zirconia, gold, base metal alloys, alumina, lithium disilicate (e.max) and titanium.

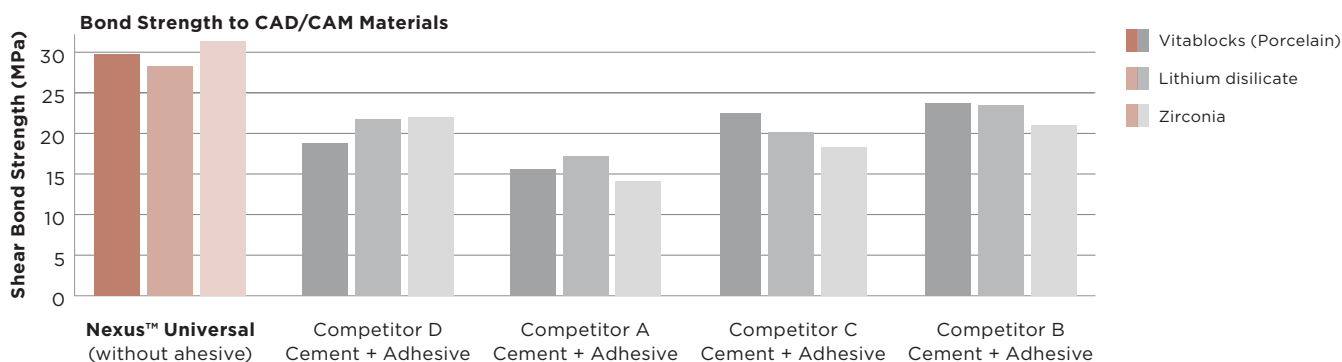

Nexus™ Universal — Intro Kit REF/Part No. 36989

4x 5g Syringes (Clear, Clear w/ Chroma, White, Yellow), 1x OptiBond Universal Bottle, 8x Automix Tips (Regular), 8x Automix Tips (Wide), 8x Intra Oral Tips, 8x Root Canal Tips, OptiBond Applicator Tips, Mixing Wells

Nexus™ Universal — Trial Kit REF/Part No. 36990

1x 5g Syringe (Clear) 8x OptiBond Universal Unit Dose Pawns, 8x Automix Tips (Regular), OptiBond Applicator Tips

Nexus™ Universal — Refills REF/Part No.

2x 5g Syringes, 8x Automix Tips (Regular), 8x Automix Tips (Wide), 8x Intra Oral Tips

Nexus Universal — Clear	36991
Nexus Universal — Clear with Chroma	36992
Nexus Universal — White	36993
Nexus Universal — White Opaque	36994
Nexus Universal — Yellow	36995
Nexus Universal — Bleach	36996

Nexus™ Universal — Accessories REF/Part No.

Nexus Universal — 50x Mixing Tips (Regular)	36999
Nexus Universal — 50x Mixing Tips (Wide)	37000



Nexus™ Universal — Intro Kit



Nexus™ Universal — Refills

NX3 Nexus™ Third Generation

Dual-cure resin cement

Universally indicated for all indirect applications, NX3 is a permanent resin cement system with an innovative chemistry for unmatched aesthetics, adhesion and versatility. With a proprietary amine-free initiator system by Kerr and an optimised resin matrix, NX3 is truly colour stable.

The automixing dual-cure cement can be used for all indirect applications. The light-cure variants with matching try-in gels are ideal for veneers and indications requiring unlimited work time.

NX3 can be used with a total etch, selective etch or self-etch bonding system.



NX3 Nexus™ Third Generation — Refills and Accessories	REF/Part No.
NX3 Nexus Third Generation — 5g Automix Dual-Cure Syringe - Clear	33643
NX3 Nexus Third Generation — 5g Automix Dual-Cure Syringe - White	33644
NX3 Nexus Third Generation — 5g Automix Dual-Cure Syringe - Yellow	33645
NX3 Nexus Third Generation — 5g Automix Dual-Cure Syringe - Bleach	33646
NX3 Nexus Third Generation — 5g Automix Dual-Cure Syringe - White Opaque	33647
NX3 Nexus Third Generation — 1.8g Light-Cure Syringe - Clear	33648
NX3 Nexus Third Generation — 1.8g Light-Cure Syringe - White	33649
NX3 Nexus Third Generation — 1.8g Light-Cure Syringe - Yellow	33650
NX3 Nexus Third Generation — 1.8g Light-Cure Syringe - Bleach	33651
NX3 Nexus Third Generation — 1.8g Light-Cure Syringe - White Opaque	33652
NX3 Nexus Third Generation — 50x Automix Tips	33655



Cavalite

Light-cured cavity liner

Cavalite is a light-cured cavity liner containing hydroxyapatite and glass ionomer powder.

Cavalite

REF/Part No. 20282

10 ml Cavalite, 1 Mixing Pad



Cavalite

Life™

Pulp-capping material

Life™ is a calcium hydroxide cavity liner available in both regular and fast set.

Life™ — Regular Set — Standard Package

REF/Part No. 61769

12 g Base, 12 g Catalyst, 1 Mixing Pad

Life™ — Regular Set — Bulk package

REF/Part No. 60927

5 x 12 g Base, 5 x 12 g Catalyst, 5 Mixing Pad

Life™ — Fast Set — Standard package

REF/Part No. 60997

12 g Base, 12 g Catalyst, 1 Mixing Pad

Life™ — Fast Set — Bulk package

REF/Part No. 60998

5 x 12 g Base, 5 x 12 g Catalyst, 5 Mixing Pad



Life™ — Fast Set — Standard package

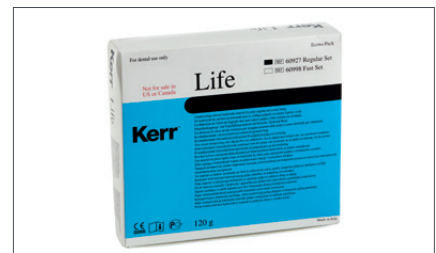

Life™ — Regular Set — Bulk package

3.7 Curing lights

Demi™ Plus

Light emitting diode (LED) curing light

Thanks to the PLS technology, Demi Plus intermittently shifts the output intensity from a base of 1,100 mW/cm² to a peak of 1,330 mW/cm². This enables the Demi Plus to deliver a 5-second cure for A3 or lighter shades.



Enhanced Body Design

This curing light's exterior is made from Valox resin, a high-performance plastic that will protect and extend the life of your unit. In addition, the upgraded closed housing allows for easier cleaning and disinfection. Improved Cooling System and fan free for quiet operation

True 5-second cure

Consistent output of Periodic Level Shifting (PLS) delivers a true 5-second cure for composite shades A3 and lighter.

Never shuts down

Whisper-quiet fan and unique thermal control system keeps the unit cool for uninterrupted operation. Extends the overall life of the unit.

Advanced battery technology

The lithium-ion battery technology can yield 300 10-second cures with a single charge.

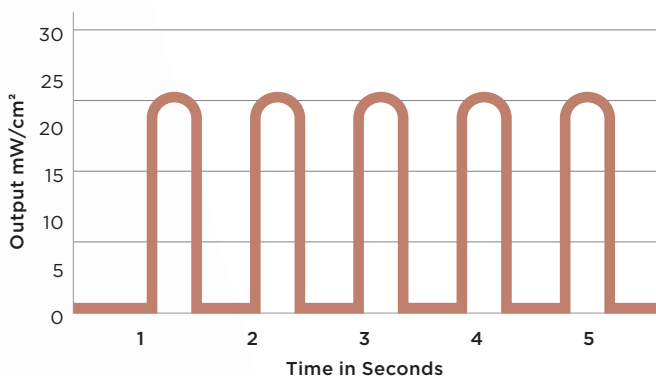

Lightweight, ergonomic design

Multiple holding options reduce hand and arm stress.

PLS Technology

Demi Plus employs the power of Periodic Level Shifting, or PLS technology, shifting output intensity from 1100 mW/cm² to a peak of 1330 mW/cm² multiple times throughout the curing cycle with a wavelength of 450 nm to 470 nm. PLS drives cool, continuous high output for a true 5-second cure without generating excess heat.

Demi™ Plus

REF/Part No. 910860-2

Demi Plus Handpiece, 8mm Turbo Extended Light Guide, 1 Lithium-ion battery, Battery charger, Power supply, Protective Light, shield, Barrier sample pack

Demi™ Plus — Accessories

REF/Part No.

Demi Plus — Battery (1 Lithium-ion battery)	921918-1
Demi Plus — Handpiece (Only handpiece)	921920-1
Demi Plus — 8 mm Turbo Extended Light Guide	921746
Demi Plus — 8 mm Turbo Light Guide	952213
Demi Plus — 4 mm Curved Turbo Light Guide (1 mm x 4 mm)	921676
Demi Plus — 2 mm Curved Light Guide (1 mm x 2 mm)	921677
Demi Plus — Battery Charger	921919-1
Demi Plus — Power Supply	952269
Demi Plus — Protective Light shield	20816
Demi Plus — Disposable Hardness disk	20399
Demi Plus — 250 Sleeves	DEMI-250

Accessories

REF/Part No.

Dem. 4 mm Curved Turbo Light Guide (1mm x 4 mm)	961676
Dem 2 mm Curved Light Guide (1mm x 2mm)	921677
Demi Curved turbo Light guide (8mm x 77 mm)	21020
Demi Curved turbo Light guide 4mm	21185



Demi™ Plus

3.8 Finishing and polishing — Discs

OptiDisc™

High-performing polishing and contouring disc

OptiDisc™ finishing and polishing discs allow you to obtain a final polish equal to that of natural dentition on all kinds of restorations. Made of durable polyester impregnated with aluminium oxide particles, the four-grit system achieves a long-lasting result.

A colour-coded system enables immediate identification of the grit type.

The flush-mounted mandrel ensures correct positioning of the disc and protects against scarring of the restoration. OptiDisc also features the choice of a short-size mandrel to facilitate access to posterior and other restricted areas.

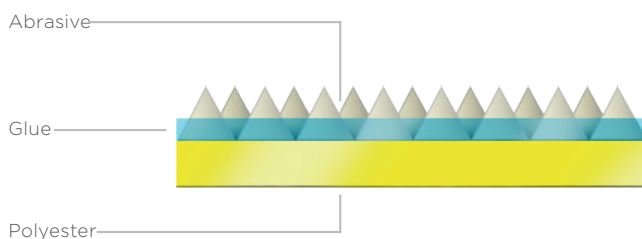

Ready to use and long-lasting performance





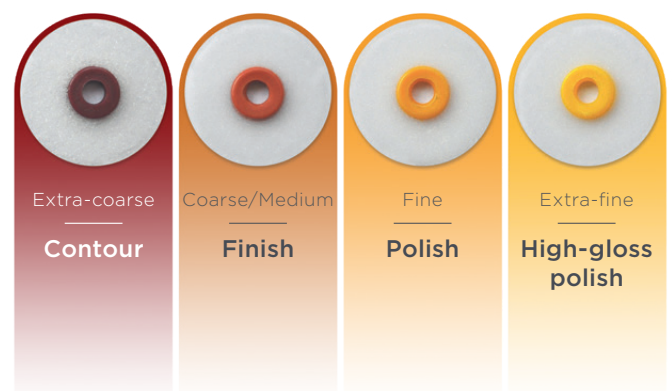

OptiDisc is made of polyester coated with aluminium oxide particles. Its abrasive layer has no extra adhesive coating, meaning the moment you fix the disc to the mandrel you are ready to go!

4 colours, 4 stages of abrasiveness

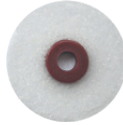
The OptiDisc system offers the choice of 4 grit level discs for contouring, finishing and high-gloss polishing. It is suitable for composite, glass ionomers, amalgams, semi-precious and precious metals. Discs are also available in three different diameter sizes depending on your needs: 9.6 mm, 12.6 mm and 15.9 mm.



A disc for all your finishing and polishing needs

Disc type	Indicated for	Anterior convex/flat area	Posterior convex/flat area	Inter-Proximal area
Extra-coarse	Gross reduction and contouring To adjust primary geometric form.			
Coarse /Medium	Finishing To remove composite excess, shape occlusal anatomy, lingual fissures and secondary anatomy.			
Fine	Polishing To erase surface scratches, and reduce surface roughness below Ra = 0.35 µm.			
Extra-fine	High-gloss polishing To reduce surface roughness to high-gloss below Ra = 0.2 µm.			

OptiDisc™ — General Assorted Kit REF/Part No. 4200

120 x ø 9.6mm Assorted OptiDisc [30 x Extra-coarse, 30 x Coarse, 30 x Fine, 30 x Extra-fine],
120 x ø 12.6mm Assorted OptiDisc [30 x Extra-coarse, 30 x Coarse, 30 x Fine, 30 x Extra-fine],
3 x Standard Mandrels, 2 x Short Mandrels, 1 x OptiShine

OptiDisc™ — Assorted Kit REF/Part No. 4190

ø 15.9mm: 20 x Extra-coarse, 20 x Coarse, 20 x Fine, 20 x Extra-fine

OptiDisc™ — Mini Kit REF/Part No. 4188

ø 12.6mm: 30 x Extra-coarse, 30 x Coarse, 30 x Fine, 30 x Extra-fine, 1 standard mandrel,
1 short mandrel, 1 OptiShine

OptiDisc™ — Refills REF/Part No.

80 x OptiDisc - 9.6 mm - Extra-coarse	4197
100 x OptiDisc - 9.6 mm - Coarse/Medium	4181
100 x OptiDisc - 9.6 mm - Fine	4182
100 x OptiDisc - 9.6 mm - Extra-fine	4183
80 x OptiDisc - 12.6 mm - Extra-coarse	4198
100 x OptiDisc - 12.6 mm - Coarse/Medium	4184
100 x OptiDisc - 12.6 mm - Fine	4185
100 x OptiDisc - 12.6 mm - Extra-fine	4186
80 x OptiDisc - 15.9 mm - Extra-coarse	4199
100 x OptiDisc - 15.9 mm - Coarse/Medium	4191
100 x OptiDisc - 15.9 mm - Fine	4192
100 x OptiDisc - 15.9 mm - Extra-fine	4193
5 x OptiDisc Standard Mandrel	195
5 x OptiDisc Short Mandrel	196



OptiDisc™ — Mini Kit

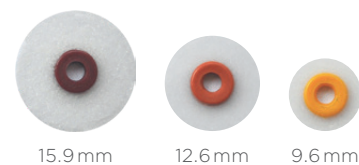

3.8 Finishing and polishing — Strips

OptiStrip™

For finishing and gloss polishing all interdental surfaces

OptiStrip™ is essential for finishing and gloss polishing all interdental surfaces, offering added value by providing a faster, higher surface gloss in only 2 steps. Ideal for polishing direct restorations including composites, glass ionomers, amalgams, semi-precious and precious metals. The abrasive particles have an optimised shape to reduce wear and keep sharpness for lasting efficiency.



OptiStrip™ — Assorted Kit

OptiStrip™ — Assorted Kit	REF/Part No. 1990
---------------------------	-------------------

4 x 50 OptiStrip of each type

OptiStrip™ — Refills	REF/Part No.
----------------------	--------------

OptiStrip — Finishing — 2 mm — Pack of 100	1991
OptiStrip — Polishing — 2 mm — Pack of 100	1992
OptiStrip — Finishing — 4 mm — Pack of 100	1993
OptiStrip — Polishing — 4 mm — Pack of 100	1994

Finishing and Polishing Strips

The abrasive strips are made of flexible polyester and are firmly coated with aluminium oxide particles. They are available in two widths and in four colour-coded grit sizes.



Finishing and Polishing Strips

Finishing and Polishing Strips — Assorted Kit	REF/Part No. 295
---	------------------

4 x 50 Finishing and Polishing Strips of each grit size

Finishing and Polishing Strips — Refills	REF/Part No.
--	--------------

Finishing and Polishing Strips — Coarse/Medium — 1.9 mm — Pack of 100	290
Finishing and Polishing Strips — Fine/Extra Fine — 1.9 mm — Pack of 100	291
Finishing and Polishing Strips — Coarse/Medium — 3.9 mm — Pack of 100	292
Finishing and Polishing Strips — Fine/Extra Fine — 3.9 mm — Pack of 100	293

3.8 Finishing and polishing — Brushes

Occlubrush™

One-step polishing brush system

Occlubrush™ comes in a variety of shapes precisely matched for use on occlusal and interproximal areas of indirect restorations. It is designed for the pre-polishing and high-gloss polishing of composites, compomers, resin-modified glass ionomers and ceramics with one instrument.

Bristle fibres impregnated with silicon carbide particles eliminate the need for paste.





Occlubrush™

Occlubrush™ — Assorted Kit REF/Part No. 2520

5x Occlubrush regular cup, 5x Occlubrush small cup, 5x Occlubrush point.

Occlubrush™ — Refills REF/Part No.

	Regular Cup	Pack of 3	2503
		Pack of 10	2510
	Small Cup	Pack of 3	2504
		Pack of 10	2511
	Point	Pack of 3	2505
		Pack of 10	2512

OptiShine™

Concave-shaped polishing brush

OptiShine™ produces excellent polishing results for all restorations due to the concave shape of the brush. This ensures efficiency on all teeth and on less accessible surfaces like interproximal spaces and occlusal fissures.

OptiShine™ REF/Part No.

OptiShine — Pack of 3	2513
OptiShine — Pack of 10	2514

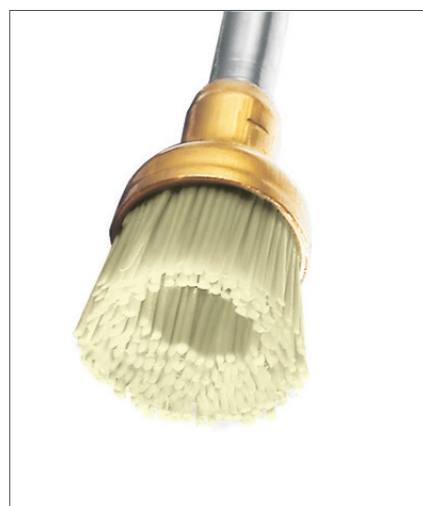

OptiShine™

3.8 Finishing and polishing — Composite polishers

Opti1Step™

One-Step polishing system

Opti1Step™ is a multiple-use polishing system for direct composite restorations that enables the creation of a smooth surface and high-gloss in just One-Step.

The pre-embedded abrasive matrix allows high-gloss polishing without the need for paste. Its optimised flexibility ensures easier handling and better control.

Available in three shapes:

- Discs are ideal for facial surfaces and established line angles
- Flames are ideal for posterior occlusal and concave lingual surfaces
- Cups are well suited for molar cusps, and cervical and proximal line angle areas



Opti1Step™

Opti1Step™ — Assorted Kit

REF/Part No. 8000

12 Composite Opti1Step Polisher: 4 Flames, 4 Cups, 4 Discs

Opti1Step™ — Assorted Mini Kit

REF/Part No. 8004

6 Composite Opti1Step Polisher: 2 Flames, 2 Cups, 2 Discs

Opti1Step™ — Refills

REF/Part No.









Opti1Step — Flame — Pack of 12	8001
Opti1Step — Cup — Pack of 12	8002
Opti1Step — Disc — Pack of 12	8003

HiLuster^{PLUS} Polishing System

Two-Step polishing system

HiLuster^{PLUS} is a two step polishing system.

- Gloss^{PLUS} aluminium oxide polishers are used for smoothing and polishing the surface after contouring with a carbide bur.
- The HiLuster^{PLUS} Dia diamond polishers follow to give the final shine.

Gloss ^{PLUS} — Refills			REF/Part No.
	Flame	Pack of 6	2651
	Minipoint	Pack of 6	2652
	Cup	Pack of 6	2653
	Disc	Pack of 6	2654
HiLuster ^{PLUS} — Refills			REF/Part No.
	Flame	Pack of 6	2661
	Minipoint	Pack of 6	2662
	Cup	Pack of 6	2663
	Disc	Pack of 6	2664
Polishing Assorted Kit			REF/Part No. 5100

2 Gloss^{PLUS} Polishers Flame, 2 Gloss^{PLUS} Polishers Cup, 2 HiLuster^{PLUS} Polishers Flame, 2 HiLuster^{PLUS} Polishers Cup, 5 OptiDisc 12,6 mm Coarse/Medium, 5 OptiDisc 12,6 mm Fine, 5 OptiDisc 12,6 mm Extra-fine, 2 OptiDisc Standard Mandrels, 1 OptiDisc Short Mandrel

Identoflex™ Composite Polishers

Identoflex is a three-step system to be applied immediately after contouring. The colour-coding makes identification easy at each stage:

- Yellow: pre-polishers
- Grey: gloss polishers
- White: high-gloss polishers



Identoflex Composite Polishers

Identoflex Composite Polishers - Pre-polishers Testset - Yellow REF/Part No. ID 5101/8

Pack of 8 assorted

Identoflex Composite Polishers - High-Gloss Polishers Testset - White REF/Part No. ID 5501/8

Pack of 8 assorted

Identoflex Composite Polishers - Pre-polishers Yellow - Refills REF/Part No.

	Flame	Pack of 12	ID 5021/12
	Large Cup	Pack of 12	ID 5031/12
	Lenticular	Pack of 12	ID 5041/12
	Minipoint	Pack of 12	ID 5061/12
	Minipoint Small	Pack of 12	ID 5071/12
	Cup	Pack of 12	ID 5081/12
	Disc	Pack of 12	ID 5091/12

Identoflex Composite Polishers - Gloss Polishers Grey - Refills REF/Part No.

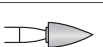
	Flame	Pack of 12	ID 5221/12
	Minipoint	Pack of 12	ID 5261/12
	Cup	Pack of 12	ID 5281/12
	Disc	Pack of 12	ID 5291/12

Identoflex Composite Polishers — Polishers White — Refills REF/Part No.

	Flame	Pack of 12	ID 5421/12
	Large Cup	Pack of 12	ID 5431/12
	Lenticular	Pack of 12	ID 5441/12
	Minipoint	Pack of 12	ID 5461/12
	Minipoint Small	Pack of 12	ID 5471/12
	Cup	Pack of 12	ID 5481/12
	Disc	Pack of 12	ID 5491/12





Identoflex™ Diamond Composite Polishers

Identoflex Diamond Composite Polishers are used for the polishing of composites, compomers and glass ionomers. The twin-zone technology takes into account the typical wear pattern: only the active zone is therefore impregnated with diamond grit. Thanks to the high polishing ability of the diamond, low revolutions can be used. Therefore, any overheating that could damage the pulp and filling materials is avoided. Available in four shapes.

Identoflex Diamond Composite Polishers — Assorted Testset REF/Part No. ID 5601/6

Pack of 6 assorted

Identoflex Diamond Composite Polishers — Refills REF/Part No.

	Disc	Pack of 12	ID 5611/12
	Flame	Pack of 12	ID 5621/12
	Cup	Pack of 12	ID 5681/12
	Minipoint	Pack of 12	ID 5691/12

3.8 Finishing and polishing — Ceramic polishers

Identoflex™ Diamond Ceramic Polishers

Identoflex Diamond Ceramic Polishers are twin-zone diamond polishers used for treating ceramics at chair-side. The twin-zone technology takes into account the typical wear pattern: only the active zone is therefore impregnated with diamond grit. Thanks to the high polishing ability of the diamond, low revolutions can be used. Therefore, any overheating that could damage the pulp and filling materials is avoided. Available in four shapes.







Identoflex™ Diamond Ceramic Polishers

Identoflex™ Diamond Ceramic Polishers — Assorted Testset REF/Part No. ID 5701/4

Pack of 4 assorted

Identoflex™ Diamond Ceramic Polishers — Refills REF/Part No.

	Disc	Pack of 6	ID 5711/12
	Flame	Pack of 6	ID 5721/12
	Cup	Pack of 6	ID 5781/12
	Minipoint	Pack of 6	ID 5791/12

3.8 Finishing and polishing — Amalgam polishers

AABA™-Dental Universal

Universal pre-polishing programme for all filling materials.
Available in five shapes.



AABA™-Dental Universal — Refills			REF/Part No.
	Rounded Torpedo	Pack of 12	ID 3011/12
	Flame	Pack of 12	ID 3021/12
	Minipoint	Pack of 12	ID 3031/12
	Large Cup	Pack of 12	ID 3091/12
	Cup	Pack of 12	ID 3151/12

Identoflex™ Gold/Amalgam/Precious Metal Alloys

Specially developed for dental metals, these polishers achieve a high-gloss in two steps.

Identoflex™ Gold/Amalgam/Precious Metal Alloys - Assorted Testset REF/Part No. ID 4101/6

Pack of 6 assorted prepolishers — Brown

Identoflex™ Gold/Amalgam/Precious Metal Alloys - Pre-polishers Brown - Refills			REF/Part No.
	Lenticular	Pack of 12	ID 4021/12
	Flame	Pack of 12	ID 4041/12
	Cup	Pack of 12	ID 4051/12
	Minipoint	Pack of 12	ID 4061/12
	Minipoint Small	Pack of 12	ID 4071/12

3.9 Alloys

Contour™

Dispersed phase silver amalgam

Contour™ is a dispersed phase (admix) alloy that features a firm pack with smooth carving. With 70% spherical and 30% lathe-cut particles, dentists get more body for better contacts in an easy-to-condense formulation. Contour dental amalgam helps avoid chipping and flaking of marginal ridges.



Contour — Standard Package — 50x 600 mg

Contour™ — Refills

REF/Part No.

Contour — Standard Package — 50x 400mg Capsules Single Spill	29963
Contour — Standard Package — 50x 600mg Capsules Double Spill	29966
Contour — Bulk Package — 500x 600mg Capsules Double Spill	31348

Tytin™

Spherical silver amalgam

With a high silver content and patented spherical particle formula, Tytin™ produces a consistent amalgam restoration. It is extremely smooth and easy-to-place and carve. The excellent marginal integrity has been well documented. It maintains its lustre over time and accepts immediate polishing in Class I restorations.



Tytin — Standard Package — 50x 400mg

Tytin™ — Regular Set — Blue — Refills

REF/Part No.

Tytin — Standard Package — 50x 400mg Capsules Single Spill	29945
Tytin — Bulk Package — 500x 400mg Capsules Single Spill	29946
Tytin — Standard Package — 50x 600mg Capsules Double Spill	29948
Tytin — Bulk Package — 500x 600mg Capsules Double Spill	31345
Tytin — Standard Package — 50x 800mg Capsules Triple Spill	29951
Tytin — Bulk Package — 500x 800mg Capsules Triple Spill	31346

Tytin™ — Slow Set — Light Blue — Refills

REF/Part No.

Tytin — Standard Package — 50x 400mg Capsules Single Spill	29954
Tytin — Standard Package — 50x 600mg Capsules Double Spill	29957
Tytin — Bulk Package — 500x 600mg Capsules Double Spill	29958
Tytin — Standard Package — 50x 800mg Capsules Triple Spill	29960



Tytin — Bulk Package — 500x 400mg

Tytin™ FC (Firm Condensation)

Firm packing silver amalgam

This “hybrid” is neither a spherical nor an admix alloy. The patented particle formula features easier handling than with a traditional admix as there are no heavy lathe-cut particles. Tytin™ FC offers the performance of Tytin but with the packing resistance of an admix.

Tytin™ FC — Regular Set — Dark Grey — Refills	REF/Part No.
Tytin FC — Standard Package — 50 x 400 mg Capsules Single Spill	29981
Tytin FC — Standard Package — 50 x 600 mg Capsules Double Spill	29984
Tytin FC — Bulk Package — 500 x 600 mg Capsules Double Spill	29985

Tytin™ FC — Slow Set — Yellow — Refills	REF/Part No.
Tytin — Standard Package — 50 x 600 mg Capsules Double Spill	29993
Tytin — Bulk Package — 500 x 600 mg Capsules Double Spill	29994

Construct

Braided Fibre Reinforcement Ribbon

An ultra-high-strength polyethylene fibre that is cold gas plasma treated and is pre-silanated with unfilled resin. Construct can be handled prior to wetting the Construct fibres. This allows easier handling, saving time and cost.

Construct — Refills	REF/Part No.
Construct — Ribbon Spool — 1mm — approx. 90 cm Length	30870
Construct — Ribbon Spool — 2mm — approx. 90 cm Length	30871
Construct — Ribbon Spool — 3mm — approx. 90 cm Length	30872
Construct — Resin Untinted — 3.5g Syringe	30873
Construct — Resin Light — 3.5g Syringe	30874
Construct — Resin Dark — 3.5g Syringe	30875
Construct — Scissors	26959



Construct



Construct

3.10 Restorative accessories — Posterior matrices

MetaFix™

All-in-one matrix system

The All-in-One MetaFix™ matrix, with the innovative integrated tightening/opening system, is the perfect solution for Class II - MO/OD/MOD composite fillings.

- Immediate positioning and removal with no extra tools needed
- Effective contact points and cervical adaptation
- Clear visibility, excellent patient comfort
- 0.038 mm thickness

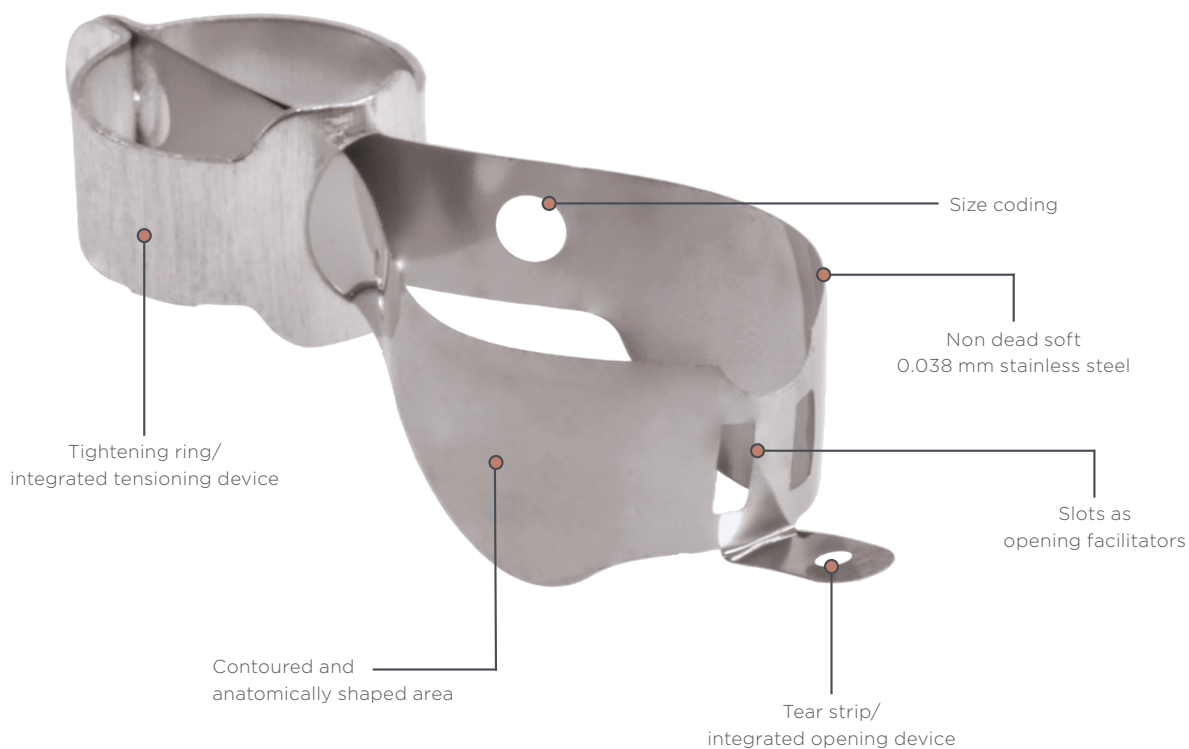

MetaFix™ — Refills				REF/Part No.
Size	Max. perimeter of matrix in open position	Min. perimeter of matrix in closed position	Height in the proximal area	Pack of 50
Small (Premolar)	27 mm	19 mm	6.7 mm	3601
Medium (Molar regular)	33 mm	25 mm	6.3 mm	3602
Large (Molar large)	40 mm	32 mm	7.8 mm	3603

MetaFix™ — Assorted Kit REF/Part No. 3604
 150 MetaFix: 50x Small, 50x Medium, 50x Large.

Lucifix™

Posterior matrices with integrated fixing device

Lucifix™ has an integrated tightening device with no holder needed. The matrix can be released by cutting it. The blue and transparent range allow better visual control of the composite application, filling procedure and handling.

Blue Lucifix™ — Refills	REF/Part No.
Blue Lucifix — Premolar Matrices — Pack of 50	2775
Blue Lucifix — Molar Matrices — Pack of 50	2776

Transparent Lucifix™ — Refills	REF/Part No.
Transparent Lucifix — Premolar Matrices — Pack of 50	775
Transparent Lucifix — Molar Matrices — Pack of 50	776

Transparent Lucifix/ Adapt Luciwedge	REF/Part No. 785 S
30 Transparent Lucifix premolar matrices, 15 Transparent Lucifix molar matrices, 60 Adapt Luciwedges (15 of each size: ultra-small, small, medium, large)	



Blue Lucifix™



Transparent Lucifix™

SuperMat™

Universal matrix tensioning system

The SuperMat™ universal tensioning system is ideal for both transparent or steel posterior matrices. Easy-to-use and time saving, it is comfortable for the patient, as no retainer is left in the mouth. SuperMat fits the matrices anatomically, reducing the finishing work required.

Use with:

- The Adapt™ SuperCap™ Matrix - ready-to-use matrices with integrated spool to fix them to the SuperMat
- The SuperCap™ Spools - to fix one of the Kerr range of SuperMat-compatible matrices

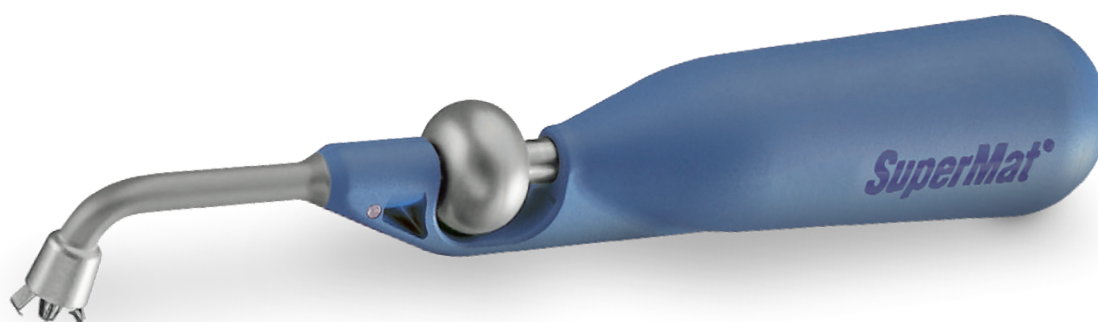

Adapt SuperCap Matrices — Refills					REF/Part No.
	Dead-Soft Steel	0.030 mm	High 5.0 mm	Pack of 50	2161
	Dead-Soft Steel	0.030 mm	High 6.3 mm	Pack of 50	2162
	Non-Dead-Soft Steel	0.038 mm	High 5.0 mm	Pack of 50	2181
	Non-Dead-Soft Steel	0.038 mm	High 6.3 mm	Pack of 50	2182
	Transparent	0.050 mm	High 5.0 mm	Pack of 50	2171
	Transparent	0.050 mm	High 6.3 mm	Pack of 50	2172



SuperMat™ — Assorted Kit

SuperLock	REF/Part No. 2160
1x SuperLock tensioning instrument	

SuperMat™ — Assorted Kit	REF/Part No. 2150
1x SuperLock tensioning instrument, 14x Adapt SuperCap Steel Matrices assorted, 6x Adapt SuperCap Transparent Matrices assorted	

Adapt SuperCap Spool — Refills	REF/Part No.
SuperCap Spool - 5.6 mm — Pack of 100	2010
SuperCap Spool - 5.6 mm — Pack of 500	2020
SuperCap Spool - 6.7 mm — Pack of 100	2015
SuperCap Spool - 6.7 mm — Pack of 500	2025

Adapt™ and Contoured Matrices

- 0.045 mm thickness
- Suitable for proximal areas
- Easy-to-insert in interproximal area
- Contoured versions available where extra cushioning is needed
- Can be used with SuperMat System by applying the SuperCap Spool

Adapt™ Matrices	REF/Part No.
Adapt Matrices – 0.045mm Thin – Pack of 30	375
Adapt Matrices – 0.045mm Thin – Pack of 30	376
Adapt Matrices – 0.045mm Thin – Pack of 30	377
Adapt Matrices – 0.045mm Thin – Pack of 30	378
Adapt Matrices – 0.045mm Thin – Pack of 30	379
Adapt Matrices – 0.045mm Thin – Pack of 30	380
Adapt Matrices – 0.045mm Thin – Pack of 30	382

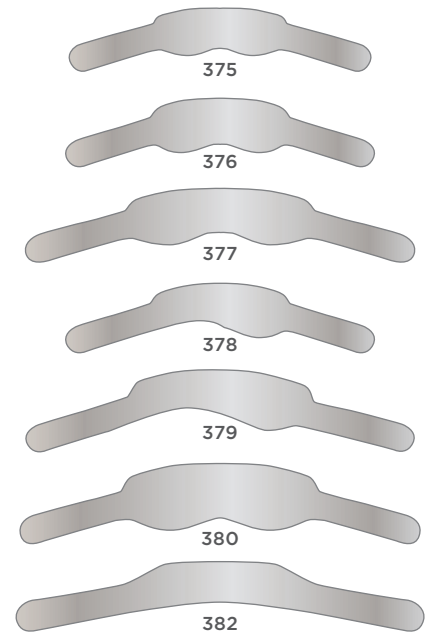

Contoured Matrices	REF/Part No.
Contoured Matrices – 0.045mm Thin – Premolar – Bilateral – Pack of 30	390
Contoured Matrices – 0.045mm Thin – Molar – Bilateral – Pack of 30	391
Contoured Matrices – 0.045mm Thin – Premolar – Unilateral – Pack of 30	392
Contoured Matrices – 0.045mm Thin – Premolar – Unilateral – Pack of 30	393
Contoured Matrices – 0.045mm Thin – Molar – Unilateral – Pack of 30	394
Contoured Matrices – 0.045mm Thin – Molar – Unilateral – Pack of 30	395

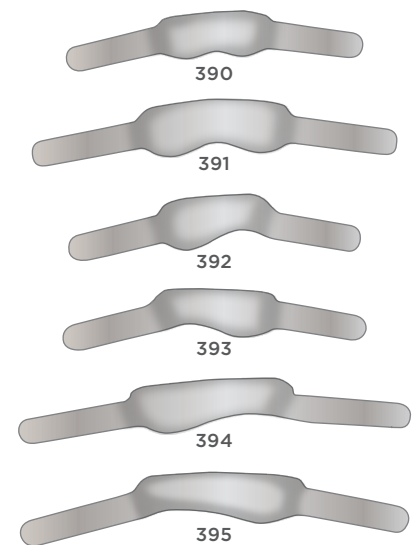

Micro and Super Thin Matrices

- Stainless steel, 0.030 mm or 0.038 mm thickness
- Use for both molar and premolar restorations
- Suitable for proximal areas
- Great adaptability to tooth structure
- Can be used with SuperMat System by applying the SuperCap Spool

Micro Thin Matrices	REF/Part No.
Micro Thin Matrices – 0.03mm Thin – Pack of 30	405
Micro Thin Matrices – 0.03mm Thin – Pack of 30	406
Micro Thin Matrices – 0.03mm Thin – Pack of 30	407
Micro Thin Matrices – 0.03mm Thin – Pack of 30	408
Micro Thin Matrices – 0.03mm Thin – Pack of 30	409
Micro Thin Matrices – 0.03mm Thin – Pack of 30	410

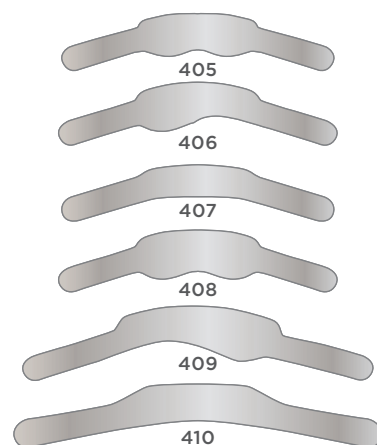

Super Thin Matrices	REF/Part No.
Super Thin Matrices – 0.038mm Thin – Pack of 30	1201
Super Thin Matrices – 0.038mm Thin – Pack of 30	1202
Super Thin Matrices – 0.038mm Thin – Pack of 30	1203
Super Thin Matrices – 0.038mm Thin – Pack of 30	1204
Super Thin Matrices – 0.038mm Thin – Pack of 30	1205
Super Thin Matrices – 0.038mm Thin – Pack of 30	1206
Super Thin Matrices – 0.038mm Thin – Pack of 30	1207
Super Thin Matrices – 0.038mm Thin – Pack of 30	1208

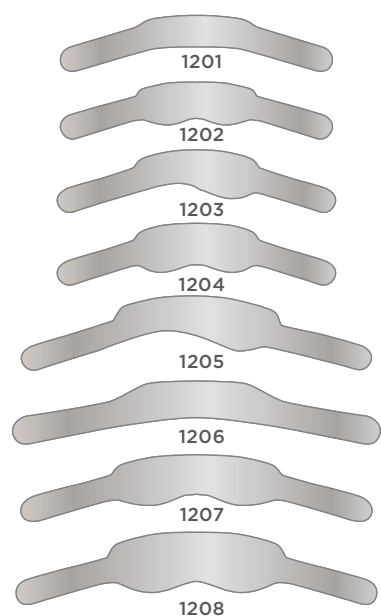

Premolar and Molar Matrices

- Anatomically shaped, 0.075 mm thickness
- Transparent version is colour-coded for easy selection
- No discolouration when in contact with etching gels, bonds and primers
- Can be used with SuperMat System by applying the SuperCap Spool



Transparent Molar Matrices

Premolar and Molar Matrices — Transparent — Refills	REF/Part No.
Transparent Premolar Matrices — Pack of 50	773
Transparent Molar Matrices — Pack of 50	774



Transparent Posterior Matrix System

Transparent Posterior Matrix System	REF/Part No. 780 S
40 Transparent Premolar Matrices, 20 Transparent Molar Matrices, 15 Adapt Luciwedges of each size: ultra small, small, medium, large	

Tofflemire Matrices

- Available in 0.05 mm and 0.038 mm thickness
- Standard or contoured depending on need
- Can be used with SuperMat System by applying the SuperCap Spool, or with a traditional matrix retainer



Tofflemire Contoured Matrices

Tofflemire Matrices — Refills	REF/Part No.
Tofflemire Matrices — 0.050mm Thin — Pack of 30	1001/30
Tofflemire Matrices — 0.038mm Thin — Pack of 30	1101/30
Tofflemire Matrices — 0.050mm Thin — Pack of 30	1002/30
Tofflemire Matrices — 0.038mm Thin — Pack of 30	1102/30
Tofflemire Matrices — 0.050mm Thin — Pack of 30	1003/30
Tofflemire Matrices — 0.038mm Thin — Pack of 30	1103/30
Tofflemire Matrices — 0.050mm Thin — Pack of 30	1013/30
Tofflemire Matrices — 0.038mm Thin — Pack of 30	1113/30
Tofflemire Matrices — 0.050mm Thin — Pack of 30	1015/30
Tofflemire Matrices — 0.038mm Thin — Pack of 30	1115/30
Tofflemire Contoured Matrices — 0.050mm Thin — Pack of 30	1001 C
Tofflemire Contoured Matrices — 0.038mm Thin — Pack of 30	1101 C

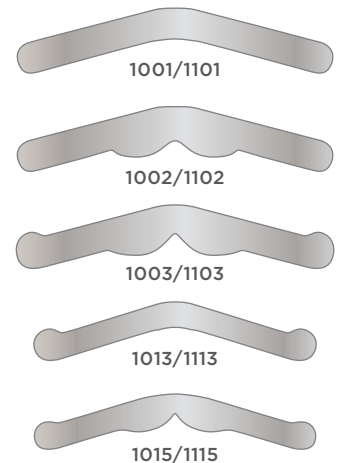

Titanium Matrices

- 0.03 mm thickness
- Available for molar, premolar/contoured or double-sided
- Suitable for proximal areas
- Great adaptability to tooth structure
- Can be used with SuperMat System by applying the SuperCap Spool

Titanium Matrices – Refills	REF/Part No.
Titanium Matrices – 0.03mm Thin – Premolar – Pack of 30	1501
Titanium Matrices – 0.03mm Thin – Premolar – Double-sides – Pack of 30	1502
Titanium Matrices – 0.03mm Thin – Molar – Pack of 30	1506
Titanium Matrices – 0.03mm Thin – Molar – Double-sides – Pack of 30	1507
Titanium Contoured Matrices – 0.03mm Thin – Pack of 30	1590
Titanium Contoured Matrices – 0.03mm Thin – Pack of 30	1591

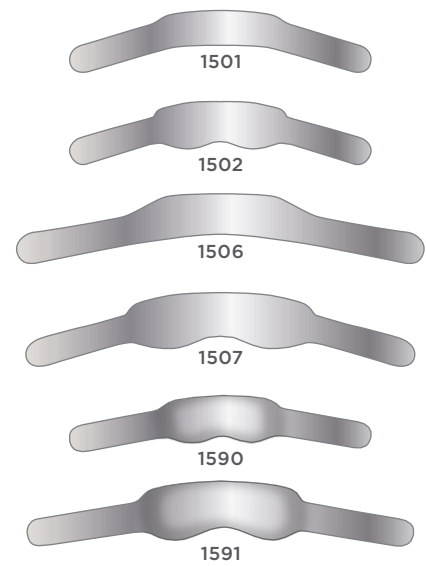

Steel Matrix Bands

- Handy matrix dispenser to cut the strip at preferred length
- To be used for non-deep cavities
- Easy-to-handle and store

Steel Matrix Bands	REF/Part No.
Steel Matrix Bands – Blue – 0.030 mm Thin – Width 5 mm – 3 m	399 A
Steel Matrix Bands – Blue – 0.030 mm Thin – Width 6 mm – 3 m	399 B
Steel Matrix Bands – Blue – 0.030 mm Thin – Width 7 mm – 3 m	399 C
Steel Matrix Bands – Transparent – 0.045 mm Thin – Width 5 mm – 3 m	499 A
Steel Matrix Bands – Transparent – 0.045 mm Thin – Width 6 mm – 3 m	499 B
Steel Matrix Bands – Transparent – 0.045 mm Thin – Width 7 mm – 3 m	499 C



Striproll – Blue



Striproll – Transparent

3.10 Restorative accessories — Anterior and cervical matrices

Adapt™ Sectional Matrix System

- Suitable for small cavities and micro-restorations
- Transparent or blue depending on personal preference
- To be used in conjunction with Rings and forceps



Adapt Sectional Matrix System

Blue Adapt Sectional Matrix Kit REF/Part No. 2750

200 assorted Blue Sectional Matrices (4 x 50), 200 approximal shapers, 1 application forceps, 5 each Adapt Luciwedges (small, medium, large)

Blue Adapt Sectional Matrices - Refill with Approximal Shapers - Pack of 100 REF/Part No.

Blue Adapt Sectional Matrices - H. 5.0 mm - Thickness 0.05 mm - moderate curve	2751
Blue Adapt Sectional Matrices - H. 6.5 mm - Thickness 0.05 mm - moderate curve	2752
Blue Adapt Sectional Matrices - H. 5.0 mm - Thickness 0.05 mm - increased curve	2753
Blue Adapt Sectional Matrices - H. 6.5 mm - Thickness 0.05 mm - increased curve	2754

Transparent Adapt Sectional Matrix Kit REF/Part No. 750

200 assorted Transparent Sectional Matrices (4 x 50), 200 approximal shapers, 1 application forceps, 5 each Adapt Luciwedges (small, medium, large)

Transparent Adapt Sectional Matrices - Refill with Approximal Shapers - Pack of 100 REF/Part No.

Transparent Adapt Sectional Matrices - H. 5.0 mm - Thickness 0.05 mm - moderate curve	751
Transparent Adapt Sectional Matrices - H. 6.5 mm - Thickness 0.05 mm - moderate curve	752
Transparent Adapt Sectional Matrices - H. 5.0 mm - Thickness 0.05 mm - increased curve	753
Transparent Adapt Sectional Matrices - H. 6.5 mm - Thickness 0.05 mm - increased curve	754
Blue Adapt Sectional Matrices- 1 pair of application forceps	755

Transparent Adapt Sectional Matrices - Refill w/o Approximal Shapers - Pack of 100 REF/Part No.

Transparent Adapt Sectional Matrices - H. 5.0 mm - Thickness 0.05 mm - moderate curve	756
Transparent Adapt Sectional Matrices - H. 6.5 mm - Thickness 0.05 mm - moderate curve	757
Transparent Adapt Sectional Matrices - H. 5.0 mm - Thickness 0.05 mm - increased curve	758
Transparent Adapt Sectional Matrices - H. 6.5 mm - Thickness 0.05 mm - increased curve	759

Adapt™ Transparent Strips

- Anatomically pre-shaped transparent strips
- 0.075 mm thickness
- Easy-to-use even during light curing

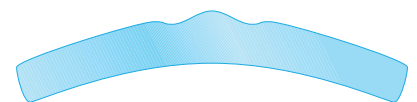

Adapt Transparent Strips REF/Part No. 680

Adapt Transparent Strips — Pack of 100

Transparent Strips

- Colour-coded to identify the appropriate width
- Composite does not stick to the matrix

Transparent Strips — Refills	REF/Part No.
Transparent Strips — Yellow — 100 mm Length — 6mm Width — Pack of 100	690
Transparent Strips — Red — 100 mm Length — 8mm Width — Pack of 100	691
Transparent Strips — Blue — 100 mm Length — 10 mm Width — Pack of 100	692
Transparent Strips — Yellow — 73 mm Length — 6 mm Width — Pack of 100	695
Transparent Strips — Red — 73 mm Length — 8mm Width — Pack of 100	696
Transparent Strips — Blue — 73 mm Length —10mm Width — Pack of 100	697

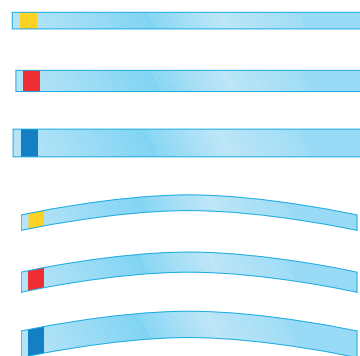

StopStrip

- Strip can be positioned and fastened safely
- No need to hold the strips with a finger
- No hindrance to light curing
- 0.050 mm thick

StopStrip — Assortment Straight	REF/Part No. 640
75x StopStrip — Straight — 8mm, 75x StopStrip — Straight — 10mm	

StopStrip — Assortment Curved	REF/Part No. 650
75x StopStrip — Curved — 8mm, 75x StopStrip — Curved — 10mm	

StopStrip — Refill	REF/Part No.
StopStrip — Straight — 8mm — Pack of 100	641
StopStrip — Straight — 10mm — Pack of 100	642
StopStrip — Curved — 8mm — Pack of 100	651
StopStrip — Curved — 10mm — Pack of 100	652



Striproll

The Striproll is a polyester strip in handy dispenser for all anterior teeth filling materials.

- 0.050mm thick
- Available in transparent or blue. Blue increases the contrast between the matrix and the tooth structure

Striproll	REF/Part No.
Striproll — Blue — 6mm Width — 15m Length	2685
Striproll — Blue — 8mm Width — 15m Length	2686
Striproll — Blue — 10mm Width — 15m Length	2687
Striproll — Transparent — 6mm Width — 15m Length	685
Striproll — Transparent — 8mm Width — 15m Length	686
Striproll — Transparent — 10mm Width — 15m Length	687



Striproll — Blue



Striproll — Transparent

Transparent Cervical Matrices

- Bendable and adaptable with less memory effect
- No manipulation needed before filling
- Compact filling without risk of composite sticking to the matrix

Transparent Cervical Matrices — Assortment REF/Part No. 850 S

35 matrices of 5 shapes (851 S–855 S), 50 matrices of 2 shapes (856 S–857 S), 1 gingival retractor, 1 holding instrument

Transparent Cervical Matrices — Refill REF/Part No.

Transparent Cervical Matrices — Pack of 150	851 S
Transparent Cervical Matrices — Pack of 150	852 S
Transparent Cervical Matrices — Pack of 150	853 S
Transparent Cervical Matrices — Pack of 150	854 S
Transparent Cervical Matrices — Pack of 150	855 S
Transparent Cervical Matrices — Pack of 150	856 S
Transparent Cervical Matrices — Pack of 150	857 S

Transparent Cervical Matrices — Accessories REF/Part No.

Transparent Cervical Matrices — Holding instrument	861
--	-----

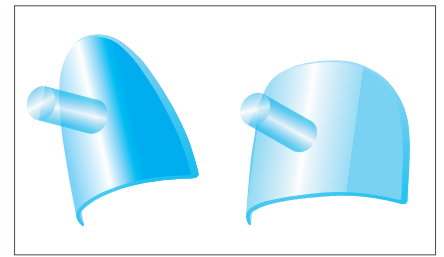

Transparent Cervical Matrices



Metal Cervical Matrices

- Adaptable metal cervical matrices have a specially treated aluminium surface
- Suitable for all self-curing composites and glass ionomers

Metal Cervical Matrices — Refill REF/Part No.

Metal Cervical Matrices — Pack of 100	719
Metal Cervical Matrices — Pack of 100	720
Metal Cervical Matrices — Pack of 100	721
Metal Cervical Matrices — Pack of 100	722
Metal Cervical Matrices — Pack of 100	723

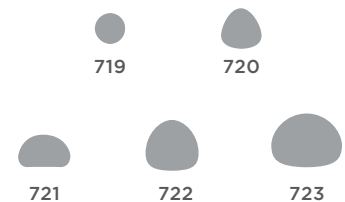

3.10 Restorative accessories — Wedges

Luciwedges Classic & Adapt Luciwedges

The high-tech solution for the separation of teeth, adaptation and the fixing of the matrix. Thanks to its light-reflecting power, Adapt Luciwedge is ideal for approximal light curing.

Luciwedges Classic — Assorted Kit REF/Part No. 790 S

100 Luciwedges Classic Soft ultra-small, 50 Luciwedges Classic Soft small, 50 Luciwedges Classic Soft medium

Luciwedges Classic — Refill REF/Part No.

Luciwedge Classic — Soft Ultra Small — Pack of 100	770 S
--	-------

Luciwedge Classic — Soft Small — Pack of 100	771 S
--	-------

Luciwedge Classic — Soft Medium — Pack of 100	772 S
---	-------

Adapt Luciwedges — Assorted Kit REF/Part No. 730

40 Adapt Luciwedges ultra small, 40 Adapt Luciwedges small, 40 Adapt Luciwedges medium, 30 Adapt Luciwedges large

Adapt Luciwedges — Refill REF/Part No.

Adapt Luciwedges — Small — Pack of 100	731
--	-----

Adapt Luciwedges — Medium — Pack of 100	732
---	-----

Adapt Luciwedges — Large — Pack of 100	733
--	-----

Adapt Luciwedges — Ultra Small — Pack of 100	734
--	-----

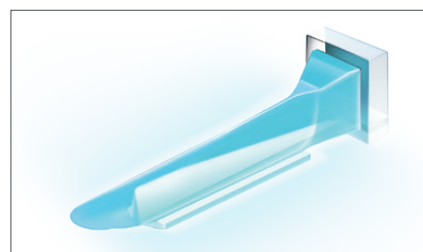

Luciwedges Classic

Sycamore Interdental Wedges

Made of splint-free sycamore wood that ensures stability and compressibility. Wedges adapt to the tooth's anatomy: they match the interdental contour, are easy-to-insert, and prevent damage to the papillae.

Sycamore Interdental Wedges — Assortments REF/Part No.

Wedge System Assortment + 1 Wedge Positioner Instrument - Pack of 1,000	830
---	-----

Sycamore Interdental Wedges - Assorted Set - Pack of 100	823
--	-----

Sycamore Interdental Wedges - Assorted Set - Pack of 400	827
--	-----

Sycamore Interdental Wedges - Wedges Dispenser - Assorted Set - Pack of 500	826
---	-----

Wedge Positioner Instrument	820
-----------------------------	-----





Sycamore Interdental Wedges

Sycamore Interdental Wedges — Refills REF/Part No.

 Turquoise (Mini)	Pack of 1,000	829/05
	Pack of 100	822/05

 Orange	Pack of 1,000	829/10
	Pack of 100	822/10

 White	Pack of 1,000	829/20
	Pack of 100	822/20

 Green	Pack of 1,000	829/30
	Pack of 100	822/30

Sycamore Interdental Wedges — Refills REF/Part No.

 Yellow	Pack of 1,000	829/40
	Pack of 100	822/40

 Blue	Pack of 1,000	829/50
	Pack of 100	822/50

 Red	Pack of 1,000	829/60
	Pack of 100	822/60

 White	Pack of 1,000	829/70
	Pack of 100	822/70

3.10 Restorative accessories — Composite restorative systems

Composite-Gun

The versatile gun for a bubble-free application of filling materials and cement. Unidose version suitable for Unidose composite formats.

Composite-Gun — Refills	REF/Part No.
Tubes and plugs — Transparent — Pack of 100	1913
Tubes and plugs — Orange low-viscosity — Pack of 100	1914
Tubes and plugs — Orange high-viscosity — Pack of 100	1915
Tubes and plugs — Orange with needle — Pack of 100	1916
Tubes and plugs — Grey — Pack of 100	1917
Tubes and plugs — Black — Pack of 100	1918
Caps in 4 different colours — Pack of 80	1919

Composite Unidose Gun Dispenser

Composite Unidose Gun Dispenser	REF/Part No. 21782
Composite Unidose Gun Dispenser	



Composite-Gun

Application System

Micro-Applicator and Micro-Brushes serve to apply liquids, medicine and varnish quickly and precisely.

Application System — Assortment	REF/Part No. 320
1 Adapter, 100 Micro-Applicators, 100 Micro-Brushes fine, 100 Micro-Brushes extra-fine	



Application System — Assortment

Application System — Refills	REF/Part No.
 Applicator Tips — Pack of 200	24680
 Wedge Positioner — Pack of 1	820

3.10 Restorative accessories — Amalgam accessories

Amalgam Guns

Resistant and easy-to-clean. Autoclavable at 134 °C, at least 3 min.

Amalgam Guns	REF/Part No.
Amalgam Gun — Straight	940
Amalgam Gun — Curved	941
Amalgam Gun — Min-I-Gun	942

Amalgam Guns	REF/Part No.
Plunger for straight model	940/1
Tip for straight model	940/2
Spring for straight model	940/3
Plunger for curved model	941/1
Tip for curved model	941/2
Spring for curved model	941/3
Plunger for Min-I-Gun	949/1
Tip for Min-I-Gun	949/2
Spring for Min-I-Gun	949/3



Amalgam Gun — Curved

3.10 Restorative accessories — Sundries

SoftClamp™

Universal rubber dam clamp

SoftClamp™ distributes the applied force evenly, reducing the pressure on the contact area. The grip-tight coating of the jaws allows SoftClamp to gently but firmly engage the tooth surface, minimising the risk of slippage and virtually eliminating the cause of patient discomfort and iatrogenic damage to the teeth.

SoftClamp™ — General Kit	REF/Part No. 5250
5 Clamps	



SoftClamp™

Mouth Mirrors

Mouth mirrors feature a front surface rhodium-coated lens. Cone socket.

Mixing Pads	REF/Part No.
Mouth Mirror — No. 4 — 22mm	15975
Mouth Mirror — No. 5 — 25mm	15976

3.11 Laboratory products — Gypsum products

Vel-Mix™ Crown & Bridge Die Stone

Type 4

A high-strength, low-expansion crown and bridge die stone. Produces smooth, hard and accurate surfaces. Exceptional flow and stacking properties enable Vel-Mix™ to be used for all model types. It is available in pink and white colour options.

Vel-Mix™ Crown & Bridge Die Stone — Pink	REF/Part No.
Vel-Mix Crown & Bridge Die Stone — Pink — 6kg	60115
Vel-Mix Crown & Bridge Die Stone — Pink — 25kg	61250
Vel-Mix™ Crown & Bridge Die Stone — White	REF/Part No.
Vel-Mix Crown & Bridge Die Stone — White — 6kg	60119 E
Vel-Mix Crown & Bridge Die Stone — White — 25kg	61251



Vel-Mix™ Crown & Bridge Die Stone — Pink



Vel-Mix™ Crown & Bridge Die Stone — White

Snow White Plaster

Type 2

Snow White is a quick-setting and reliable plaster. It is popularly used for impressions, articulation, soldering transfers, labial/occlusal indices and the fabrication of temporaries. Snow White is available in white colour, it is naturally pleasing to the eye, offering professionals a choice for all types of dental techniques.

Snow White Plaster	REF/Part No.
Snow White Plaster — 4.5kg	60113
Snow White Plaster — 20kg	61305



Snow White Plaster

Suprastone Ultra Hard Die Stone

Type 4

Suprastone Ultra Hard Die Stone is formulated for the fabrication of exceptionally hard and smooth dies/models, combining excellent physical properties with easy handling.

Suprastone Ultra Hard Die Stone — Green	REF/Part No.
Suprastone Ultra Hard Die Stone — Green — 6kg	60606 E
Suprastone Ultra Hard Die Stone — Green — 25kg	60607 E
Suprastone Ultra Hard Die Stone — Yellow	REF/Part No.
Suprastone Ultra Hard Die Stone — Yellow — 6kg	62600
Suprastone Ultra Hard Die Stone — Yellow — 25kg	62601



Suprastone Ultra Hard Die Stone — Green



Suprastone Ultra Hard Die Stone — Yellow

Hydrock™ Denture Model Stone

Type 3

Hydrock™ is ideal for full or partial models and has a setting expansion to compensate for acrylic shrinkage. It can also be used for certain crown and bridge models. Specially available in white or yellow colour options.



Hydrock™ Denture Model Stone – Yellow



Hydrock™ Denture Model Stone – White

Hydrock™ Denture Model Stone – Yellow

REF/Part No.

Hydrock Denture Model Stone – Yellow – 5kg	35822
--	-------

Hydrock Denture Model Stone – Yellow – 25kg	35820
---	-------

Hydrock™ Denture Model Stone – White

REF/Part No.

Hydrock Denture Model Stone – White – 5kg	35821
---	-------

Hydrock Denture Model Stone – White – 25kg	35819
--	-------

Orthodontic Model Mix Stone

Type 3

Orthodontic Model Mix Stone is a brilliant white fast setting, easy-to-use orthodontic model mix stone providing the perfect material for the busy ortho professional.



Orthodontic Model Mix Stone

Orthodontic Model Mix Stone

REF/Part No.

Orthodontic Model Mix Stone – Extra Hard – 25kg	61260
---	-------

Orthodontic Model Mix Stone – Hard – 25kg	61261
---	-------

Orthodontic Model Mix Stone – Regular – 25kg	61262
--	-------

Pastel Rock Die Stone

Type 4

Pastel Rock Die Stone is formulated for the fabrication of exceptionally hard, smooth dies and models. It combines excellent physical properties with easy handling.



Pastel Rock Die Stone – Yellow

Pastel Rock Die Stone – Grey

REF/Part No.

Pastel Rock Die Stone – Grey – 6kg	62605
------------------------------------	-------

Pastel Rock Die Stone – Grey – 20kg	62606
-------------------------------------	-------

Pastel Rock Die Stone – Yellow

REF/Part No.

Pastel Rock Die Stone – Yellow – 6kg	62607
--------------------------------------	-------

Pastel Rock Die Stone – Yellow – 20kg	62608
---------------------------------------	-------

3.11 Laboratory products — Restorative lab materials

Premise™ Indirect

*Nanohybrid restorative material
for indirect restorations*

The ideal nanohybrid restorative material for creating restorations that age, feel, wear, function and look like a natural tooth.

Premise™ Indirect — Master Refill Kit

REF/Part No. 33630

1 Primary Dentine 5g Syringe of each shade: A1, A2, A3, A3.5, A4, B00, B0, B1, B2, B3, B4, C1, C2, C3, C4, D2, D3, D4; 1 Facial Dentine 5g Syringe of each shade: A1, A2, A3, A3.5, A4, B00, B0, B1, B2, B3, B4, C1, C2, C3, C4, D2, D3, D4; 1 Incisal 4g Syringe of each shade: Cuspal, Neutral, Light, Grey, Clear, White; 1 Cervical (5g) Syringe: Red/Brown; 1 Kolor + Plus 2ml Bottle of each shade: Yellow, Blue, Grey, Lavender, Ochre, Untinted, Brown, Red, White; 1 Opaque 2ml Bottle of each shade: A1, A2, A3, A3.5, A4, B1, B2, B3, B4, C1, C2, C3, C4, D2, D4, Cervical; 1 each of Construct Kit, Rubber Sep 14 ml, Modelling Resin 10 ml, Silane Primer 10 ml, Composite Instrument, 1 Brush, 100 Applicator Tips, Polishing accessories

Premise™ Indirect — Intro Refill Kit

REF/Part No. 33631

1 Primary Dentine 5g Syringe of each shade: A2, A3, A3.5, B0, C2, D2; 1 Facial Dentine 5g Syringe of each shade: A2, A3, A3.5, B0, C2, D2; 1 Incisal 4g Syringe of each shade: Cuspal, Neutral, Light, Grey, Clear, White; 1 Kolor + Plus 2ml Bottle: Ochre; 1 each of Rubber Sep 14 ml, Modelling Resin 10 ml, Silane Primer 10 ml, Composite Instrument, 1 Brush, 100 Applicator, Tips, Polishing accessories

Premise™ Primary Dentin

Primary Dentins are used for foundation and coping layers. Correct application will improve strength, increase masking power and hold the chroma of a restoration.



Premise™ Primary Dentin

REF/Part No.

5g Syringe

Premise Primary Dentine — A1	33585
Premise Primary Dentine — A2	33586
Premise Primary Dentine — A3	33587
Premise Primary Dentine — A3.5	33588
Premise Primary Dentine — A4	33589
Premise Primary Dentine — B0	33590
Premise Primary Dentine — B00	33591
Premise Primary Dentine — B1	33592
Premise Primary Dentine — B2	33593

Premise™ Primary Dentin

REF/Part No.

5g Syringe

Premise Primary Dentine — B3	33594
Premise Primary Dentine — B4	33595
Premise Primary Dentine — C1	33596
Premise Primary Dentine — C2	33597
Premise Primary Dentine — C3	33598
Premise Primary Dentine — C4	33599
Premise Primary Dentine — D2	33600
Premise Primary Dentine — D3	33601
Premise Primary Dentine — D4	33602

Premise™ Facial Dentin

Facial Dentins cover all foundation and coping layers to produce a stable long-life polished surface. They display optimal translucency necessary for maximising the vitality of any restoration.



Premise™ Facial Dentine	REF/Part No.
5g Syringe	
Premise Facial Dentine – A2	33604
Premise Facial Dentine – A3	33605
Premise Facial Dentine – A3.5	33606
Premise Facial Dentine – A4	33607
Premise Facial Dentine – B0	33608
Premise Facial Dentine – B00	33609
Premise Facial Dentine – B1	33610
Premise Facial Dentine – B2	33611

Premise™ Facial Dentine	REF/Part No.
5g Syringe	
Premise Facial Dentine – B3	33612
Premise Facial Dentine – B4	33613
Premise Facial Dentine – C1	33614
Premise Facial Dentine – C2	33615
Premise Facial Dentine – C3	33616
Premise Facial Dentine – C4	33617
Premise Facial Dentine – D2	33618
Premise Facial Dentine – D4	33620

Premise™ Incisal

Incisals are placed onto the incisal/cuspal area and are designed to match the vitality of tooth enamel. They are highly opalescent and translucent. Opalescence and translucency help to create a more natural appearance.



Premise™ Incisal	REF/Part No.
4g Syringe	
Premise Incisal – Neutral	33621
Premise Incisal – Light	33622
Premise Incisal – Grey	33623
Premise Incisal – Cuspal	33624
Premise Incisal – Clear	33625
Premise Incisal – White	33626

Premise™ Indirect Solutions

Rubber Sep Clear

A removable latex release agent and spacer applied to all dies and contact areas creating a 20 micron space.

Premise™ Indirect — Rubber Sep Clear

REF/Part No. 900-675

Rubber Sep Clear — 10 ml



Rubber Sep Clear

Modelling Resin

An unfilled, universal wetting agent used to optimise bonding between cured layers, thereby minimising “white line” effects. Modelling Resin also helps when sculpturing the restoration by preventing the material from sticking to sculpturing instruments.

Premise™ Indirect — Modelling Resin

REF/Part No. 800-503

Modelling Resin — 10 ml



Modelling Resin

Silane Primer

Silane Primer is to be applied to the fitting surface of the restoration prior to bonding. It is also used for modifying or repairing fully cured restorations in conjunction with Modelling Resin.

Premise™ Indirect — Silane Primer

REF/Part No. 800-507

Silane Primer — 10 ml



Silane Primer

Premise™ Indirect Accessories

Compo Palette

Specifically designed for use with composite applications. Includes adjustable light-protected cover and replaceable four-cavity mixing-well inserts.

Premise™ Indirect — Compo Palette

REF/Part No. 27157

Compo Palette

Composite Handling Instrument

Aluminium handle, light-weight, double-ended titanium nitride-coated composite instrument.

Premise™ Indirect — Composite Handling Instrument

REF/Part No. 33550

Composite Handling Instrument

Kolor + Plus™

Resin colour modifier

Kolor + Plus™ resin offers colour modifiers for use with composite restorations. With Kolor + Plus, dentists can create just the right tint for occlusal surfaces, highlight gingival areas, simulate developmental grooves and replicate subtle details to make a restoration truly lifelike.

Kolor + Plus™ — Refills

REF/Part No.

2ml Bottle

Kolor + Plus — Yellow	23394
Kolor + Plus — Lavender	23395
Kolor + Plus — Brown	23396
Kolor + Plus — Blue	23397
Kolor + Plus — White	23398
Kolor + Plus — Red	23399
Kolor + Plus — Grey	23400
Kolor + Plus — Untinted	23401
Kolor + Plus — Ochre	23404
Kolor + Plus — Opaque A1	23402
Kolor + Plus — Opaque A3	23403



3.11 Laboratory products — Waxes

Ultra-Waxer™ 2

The electronic waxer with dual spatulas for increased productivity, tip holder for convenience and organisation, as well as easy-to-use functions, such as programmable presets and quick heat function. It has a temperature range of 36-260 °C.



Ultra-Waxer™ 2

Ultra-Waxer™ 2

REF/Part No. 34844

Ultra-Waxer – with foot control

Ultra-Waxer™ 2 Ultra-Spatula

The Ultra-Waxer™ 2 Ultra-Spatula features an all-aluminium lightweight body with interchangeable heating tips, which are colour-coded for quick identification, foam gripped for ultimate comfort and offer the ability to change the tip while still hot.



Ultra-Waxer™ 2 Ultra-Spatula

REF/Part No.

1	Ultra-Waxer 2 Ultra-Spatula — Short Heating Tip — Small PKT — Blue	35167
2	Ultra-Waxer 2 Ultra-Spatula — Short Heating Tip — Large PKT — Teal	35168
3	Ultra-Waxer 2 Ultra-Spatula — Short Heating Tip — Beavertail — Purple	35169
4	Ultra-Waxer 2 Ultra-Spatula — Short Heating Tip — Small #7 — Grey	35170
5	Ultra-Waxer 2 Ultra-Spatula — Short Heating Tip — Large #7 — Green	35171
6	Ultra-Waxer 2 Ultra-Spatula — Short Heating Tip — 1/2 Hollenback — Black	35173
7	Ultra-Waxer 2 Ultra-Spatula — Long Heating Tip — Small Denture — Pink	35174
8	Ultra-Waxer 2 Ultra-Spatula — Long Heating Tip — Large Denture — Orange	35175
9	Ultra-Waxer 2 Ultra-Spatula — Long Heating Tip — Denture Spoon — Orange	35176

3.11 Laboratory products — Lab equipment

Galetti™ Articulator

The Galetti™ Articulator is a plasterless, fixed-plane articulator, simple to use with easy adjustments.

Galetti Articulator

REF/Part No. 61332

Galetti Articulator

Galetti Articulator — Spare Parts

REF/Part No.

Later claw bolt no. 1	60492
Movable later claw bolt no. 2	60484
Tension bolt no. 3	60481
Adjusting bolt no. 4	60487
Knurled lock nut no. 5	60488
Knurled nut no. 6	60489
Tension spindle no. 9	60496
Bolt for wing nut no. 15	60494
Adjusting screw no. 21	60479 E
Locking device no. 23	60480 E
Ball shaft no. 25	60495

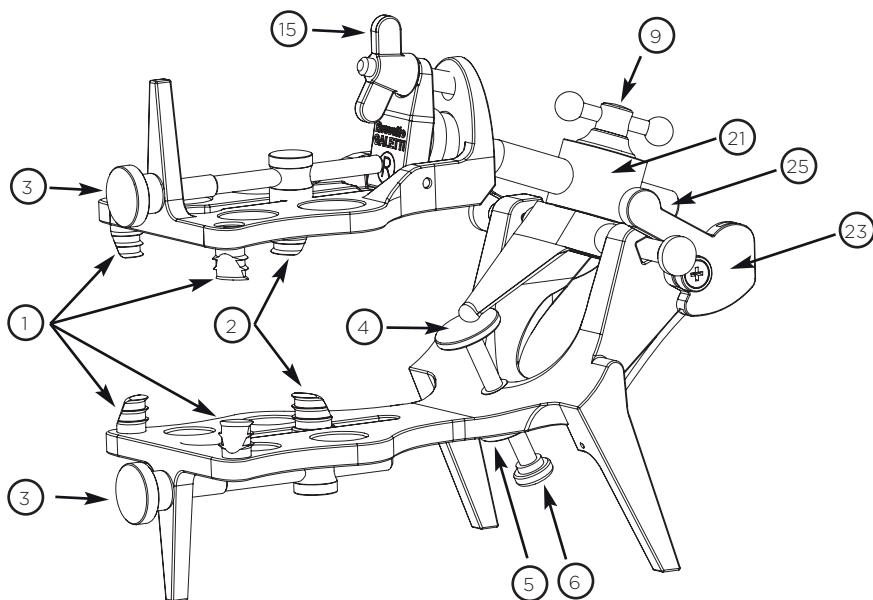

3.11 Laboratory products — Lab instruments

Smoothy™

The Smoothy™ produces a flameless jet stream of heated air and is ideal for the final stages of wax pattern sculpturing. Smoothy can also be used as a mini torch, producing a pencil-point flame with temperatures up to 1,260 °C. It is suitable for soldering precious metals and minor casting repairs. It is powered by standard butane fuel. Smoothy is supplied with one crown and bridge finishing tip.



Smoothy™

Smoothy™

REF/Part No. 013-950

Smoothy – Flameless Wax Finisher

3.11 Laboratory products — Lab solutions

Debubblizer™

Debubblizer is a surface tension reducing agent that allows investment to flow uniformly and smoothly to all portions of the wax pattern. It is designed for use with an investment vibrator.



Debubblizer™

Debubblizer™

REF/Part No. 36605

500ml Bottle

Die Spacers, Sealers, Hardeners

The Kerr Die Spacers feature finer filler particles combined with a less aggressive solvent, for a stable and user-friendly formula.



Die Spacers, Sealers and Hardeners

Die Spacers, Die Sealers, Die Hardeners

REF/Part No.

Classic Cement Spacer Blue 15 ml (20µm)

62750

Classic Cement Spacer Grey 15 ml (20µm)

62751

Classic Model Hardener/Spacer Clear 15 ml (03µm)

62760

Die Sealer/Hardener Clear 15 ml (00µm)

62761

Die Spacer Thinners 15 ml (00µm)

62762

Die Spacers, Die Sealers, Die Hardeners — Accessories

REF/Part No.

Carbide Margin Trimming Bur

013-310

Microfilm™

A non-oily, water-soluble die lubricant that allows an accurate wax pattern to be removed without distortion. It also acts as a mould release.

Microfilm™

REF/Part No. 36606

500ml Bottle



Microfilm™

Super-Sep™

An alcohol-based gypsum separating fluid that leaves no film and dries on contact. Plaster, stone or investments can be poured against it immediately following application.

Super-Sep™

REF/Part No. 36607

500ml Bottle



Super-Sep™

Tab 2000

Auto-cured acrylic material for temporary crowns, bridges and splints.

Tab 2000 — Intro Pack

REF/Part No. 61770

3 x 30g Powder, light, medium and Yellow, 2 x 30ml Liquid, Fast and Regular Set



Tab 2000 — Intro Pack

Tab 2000 — Refills

REF/Part No.

Tab 2000 — Powder only — 50g — Light	61771
--------------------------------------	-------

Tab 2000 — Powder only — 50g — Medium	61772
---------------------------------------	-------

Tab 2000 — Powder only — 50g — Yellow	61773
---------------------------------------	-------

Tab 2000 — Liquid only — 50ml — Regular Set	61774
---	-------

Tab 2000 — Liquid only — 50ml — Fast Set	61775
--	-------

Solitine

Non-irritant impression material solvent.

Solitine

REF/Part No. 60084

250ml Bottle





Solitine

3.11 Laboratory products — Miscellaneous



AABA™-Dental Universal

AABA™-Dental Universal is a universal pre-polisher for all dental lab materials.

AABA™-Dental Universal — Black			REF/Part No.
	Funnel	Pack of 12	ID 3210/12
	Lenticular Ø 15 mm	Pack of 12	ID 3240/12
	Wheel - 22 mm	Pack of 12	ID 3290/12
	Lenticular - 22 mm	Pack of 12	ID 3250/12

Identoflex™ Gold Polishers

Pre-polishers and high-gloss polishers.

Identoflex™ Gold Pre-polishers — Brown			REF/Part No.
	Lenticular	Pack of 12	ID 4022/12
	Torpedo	Pack of 12	ID 4032/12

Identoflex™ Gold High-gloss Polishers — Green			REF/Part No.
	Lenticular	Pack of 12	ID 4522/12

Lab-Min Universal

The Lab-Min Universal polishers are special unmounted polishers for acrylics and other synthetic resins, gold and non-precious metals, and hard or soft reline materials. Two grit sizes, brown (coarse) and grey (fine), enable a rapid performance and generate no heat.

Maximum speed: 15,000 rpm.

Lab-Min Universal — Standard — Brown			REF/Part No.
	Torpedo	Pack of 12	ID 1510/12

Lab-Min Universal — Fine — Grey			REF/Part No.
	Torpedo	Pack of 12	ID 1610/12
	Lab-Min Mandrel	Pack of 1	ID 1702/1

Super Acrylic Polishers

A specially developed polisher for acrylics. The dark blue polisher is used during the initial polishing phase. It will smooth coarse and rough areas of the prostheses without damaging teeth. The fine light blue polisher prepares the prostheses for final lathe polishing.







Super Acrylic Polishers





Super Acrylic Polishers — Mounted — Assortment REF/Part No. ID 2302/8

8 assorted Super Acrylic Polishers



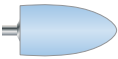

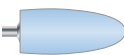
Super Acrylic Polishers — Mounted — Coarse — Dark Blue REF/Part No.

	Flame	Pack of 6	ID 2312/6
	Grenade	Pack of 6	ID 2322/6
	Narrow Flame	Pack of 6	ID 2332/6
	Cylinder	Pack of 6	ID 2342/6



Super Acrylic Polishers — Mounted — Fine — Light Blue REF/Part No.

	Flame	Pack of 6	ID 2412/6
	Grenade	Pack of 6	ID 2422/6
	Narrow Flame	Pack of 6	ID 2432/6
	Cylinder	Pack of 6	ID 2442/6

Super Acrylic Polishers — Unmounted — Coarse — Dark Blue REF/Part No.

	Flame	Pack of 12	ID 2310/12
	Grenade	Pack of 12	ID 2320/12
	Narrow Flame	Pack of 12	ID 2330/12
	Cylinder	Pack of 12	ID 2340/12

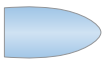
Super Acrylic Polishers — Unmounted — Fine — Light Blue REF/Part No.

	Flame	Pack of 12	ID 2410/6
	Narrow Flame	Pack of 12	ID 2430/6
	Cylinder	Pack of 12	ID 2440/6

Stainless Steel Ovals

Stainless steel ovals available in two sizes.

Stainless Steel Ovals	REF/Part No.
Stainless Steel Oval — Large	008-003
Oval Base Former — Large	008-004
Stainless Steel Oval — Small	008-013
Oval Base Former — Small	008-014



Stainless Steel Ovals

Carbide Margin Trimming Bur

The Carbide Margin Trimming Bur is a multi-faceted carbide bur for ditching stone, epoxy or plated dies.

Carbide Margin Trimming Bur	REF/Part No. 013-310
Carbide Margin Trimming Bur	



Carbide Margin Trimming Bur

Flask Liner

Non-asbestos casting ring liner.

Flask Liner	REF/Part No. 61644
21m Length x 47mm Width	



Flask Liner

Formatray

Formatray fast-cure acrylic powder and liquid produces easily manipulated, pure white, dead soft dough for the fabrication of strong, accurate custom-built trays and base plates. It sets quickly and does not distort or become rubbery, or pull away from the model during cure. It can also be used to stabilise base plates.

Formatray — Standard Package	REF/Part No. 60863
1kg Powder, 400ml Liquid	

Formatray — Bulk Package	REF/Part No. 60864
10kg Powder, 4 l Liquid	

Formatray — Refills	REF/Part No.
Formatray — 1kg Powder	60865
Formatray — 400ml Liquid	60867
Formatray — Rollette Unit only	60232



Formatray — Standard Package

Margin Liners

Margin Liners are made from an organic wax compound for ease of recognition at marginal extremities. They are available in two colours - blue and red - designed to burn out cleanly if picked up in the wax pattern.

Margin Liners	REF/Part No.
Margin Liners — Red — Pack of 36	35139
Margin Liners — Blue — Pack of 36	35140



Margin Liners — Red



Margin Liners — Blue



Kerr™

KerrHawe SA
Via Strecce 4 | 6934 Bioggio | Switzerland

The products, features and services shown and described in this catalogue are not available in all countries. All specifications were correct at the time of publication. KerrHawe SA assume no liability for deviations in colour or form from the illustrations, mistakes or printing errors and reserve the right to make changes to the brochures at any time. Reprinting, even just of excerpts, is only permitted with the consent of KerrHawe SA.